

DATA SHEET

BF908; BF908R **Dual-gate MOS-FETs**

Product specification
Supersedes data of April 1995
File under Discrete Semiconductors, SC07

1996 Jul 30

Dual-gate MOS-FETs

BF908; BF908R

FEATURES

- High forward transfer admittance
- Short channel transistor with high forward transfer admittance to input capacitance ratio
- Low noise gain controlled amplifier up to 1 GHz.

APPLICATIONS

- VHF and UHF applications with 12 V supply voltage, such as television tuners and professional communications equipment.

DESCRIPTION

Depletion type field-effect transistor in a plastic microminiature SOT143 or SOT143R package. The transistors are protected against excessive input voltage surges by integrated back-to-back diodes between gates and source.

CAUTION

The device is supplied in an antistatic package. The gate-source input must be protected against static discharge during transport or handling.

PINNING

PIN	SYMBOL	DESCRIPTION
1	s, b	source
2	d	drain
3	g ₂	gate 2
4	g ₁	gate 1

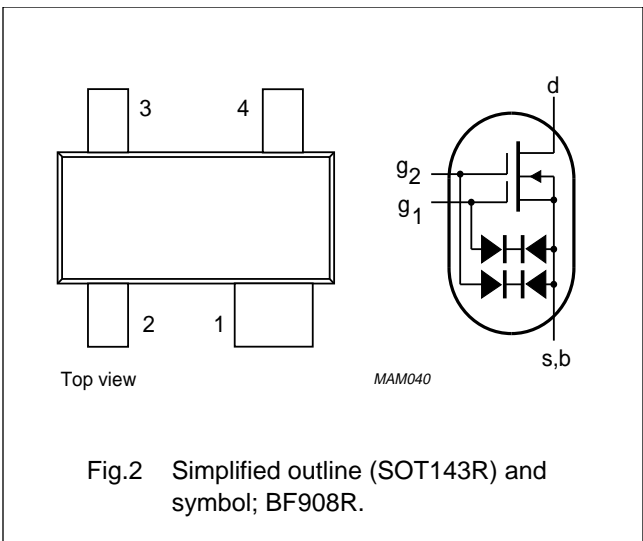
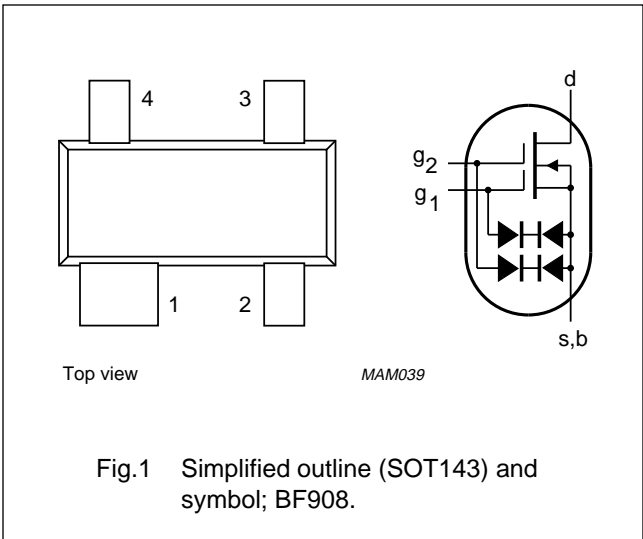

QUICK REFERENCE DATA

SYMBOL	PARAMETER	CONDITIONS	MIN.	TYP.	MAX.	UNIT
V _{DS}	drain-source voltage		–	–	12	V
I _D	drain current		–	–	40	mA
P _{tot}	total power dissipation		–	–	200	mW
T _j	operating junction temperature		–	–	150	°C
y _{fs}	forward transfer admittance		36	43	50	mS
C _{ig1-s}	input capacitance at gate 1		2.4	3.1	4	pF
C _{rs}	reverse transfer capacitance	f = 1 MHz	20	30	45	pF
F	noise figure	f = 800 MHz	–	1.5	2.5	dB

Dual-gate MOS-FETs

BF908; BF908R

LIMITING VALUES

In accordance with the Absolute Maximum Rating System (IEC 134).

SYMBOL	PARAMETER	CONDITIONS	MIN.	MAX.	UNIT
V_{DS}	drain-source voltage		–	12	V
I_D	drain current		–	40	mA
$\pm I_{G1}$	gate 1 current		–	10	mA
$\pm I_{G2}$	gate 2 current		–	10	mA
P_{tot}	total power dissipation BF908 BF908R	see Fig.3; note 1 up to $T_{amb} = 50\text{ }^\circ\text{C}$ up to $T_{amb} = 40\text{ }^\circ\text{C}$	– –	200 200	mW mW
T_{stg}	storage temperature		–65	+150	$^\circ\text{C}$
T_j	operating junction temperature		–	150	$^\circ\text{C}$

Note

1. Device mounted on a printed-circuit board.

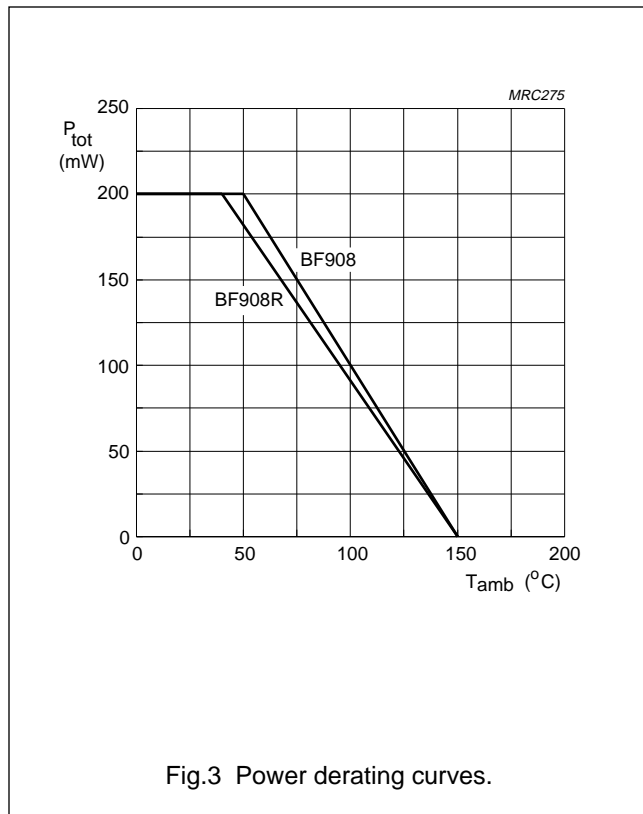

Dual-gate MOS-FETs

BF908; BF908R

THERMAL CHARACTERISTICS

SYMBOL	PARAMETER	CONDITIONS	VALUE	UNIT
$R_{th\ j-a}$	thermal resistance from junction to ambient	note 1		
	BF908		500	K/W
	BF908R		550	K/W

Note

1. Device mounted on a printed-circuit board.

STATIC CHARACTERISTICS

$T_j = 25\text{ }^\circ\text{C}$; unless otherwise specified.

SYMBOL	PARAMETER	CONDITIONS	MIN.	TYP.	MAX.	UNIT
$\pm V_{(BR)G1-SS}$	gate 1-source breakdown voltage	$V_{G2-S} = V_{DS} = 0$; $I_{G1-S} = 10\text{ mA}$	8	–	20	V
$\pm V_{(BR)G2-SS}$	gate 2-source breakdown voltage	$V_{G1-S} = V_{DS} = 0$; $I_{G2-S} = 10\text{ mA}$	8	–	20	V
$-V_{(P)G1-S}$	gate 1-source cut-off voltage	$V_{G2-S} = 4\text{ V}$; $V_{DS} = 8\text{ V}$; $I_D = 20\text{ }\mu\text{A}$	–	–	2	V
$-V_{(P)G2-S}$	gate 2-source cut-off voltage	$V_{G1-S} = 4\text{ V}$; $V_{DS} = 8\text{ V}$; $I_D = 20\text{ }\mu\text{A}$	–	–	1.5	V
I_{DSS}	drain-source current	$V_{G2-S} = 4\text{ V}$; $V_{DS} = 8\text{ V}$; $V_{G1-S} = 0$	3	15	27	mA
$\pm I_{G1-SS}$	gate 1 cut-off current	$V_{G2-S} = V_{DS} = 0$; $V_{G1-S} = 5\text{ V}$	–	–	50	nA
$\pm I_{G2-SS}$	gate 2 cut-off current	$V_{G1-S} = V_{DS} = 0$; $V_{G2-S} = 5\text{ V}$	–	–	50	nA

DYNAMIC CHARACTERISTICS

Common source; $T_{amb} = 25\text{ }^\circ\text{C}$; $V_{DS} = 8\text{ V}$; $V_{G2-S} = 4\text{ V}$; $I_D = 15\text{ mA}$; unless otherwise specified.

SYMBOL	PARAMETER	CONDITIONS	MIN.	TYP.	MAX.	UNIT
$ y_{fs} $	forward transfer admittance	pulsed; $T_j = 25\text{ }^\circ\text{C}$; $f = 1\text{ MHz}$	36	43	50	mS
C_{ig1-s}	input capacitance at gate 1	$f = 1\text{ MHz}$	2.4	3.1	4	pF
C_{ig2-s}	input capacitance at gate 2	$f = 1\text{ MHz}$	1.2	1.8	2.5	pF
C_{os}	output capacitance	$f = 1\text{ MHz}$	1.2	1.7	2.2	pF
C_{rs}	reverse transfer capacitance	$f = 1\text{ MHz}$	20	30	45	fF
F	noise figure	$f = 200\text{ MHz}$; $G_S = 2\text{ mS}$; $B_S = B_{Sopt}$	–	0.6	1.2	dB
		$f = 800\text{ MHz}$; $G_S = G_{Sopt}$; $B_S = B_{Sopt}$	–	1.5	2.5	dB

Dual-gate MOS-FETs

BF908; BF908R

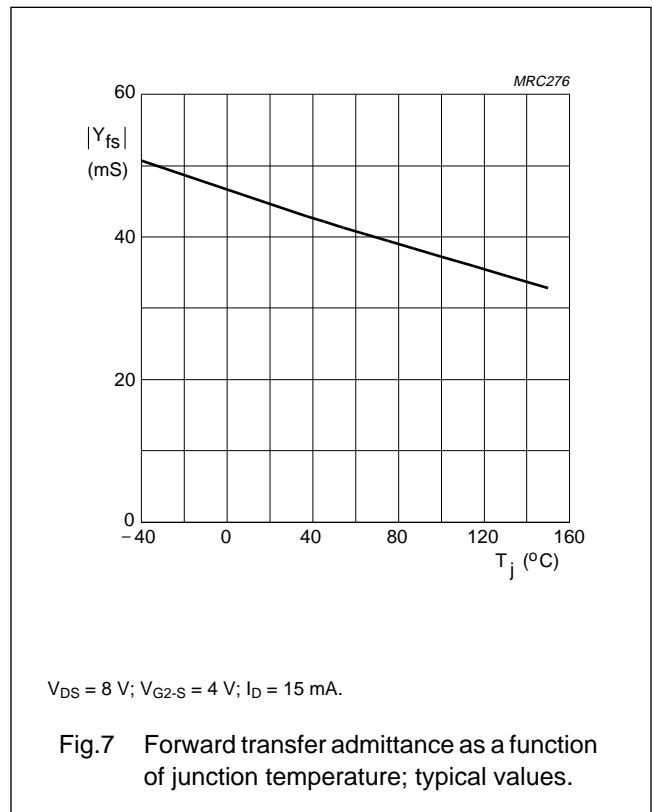
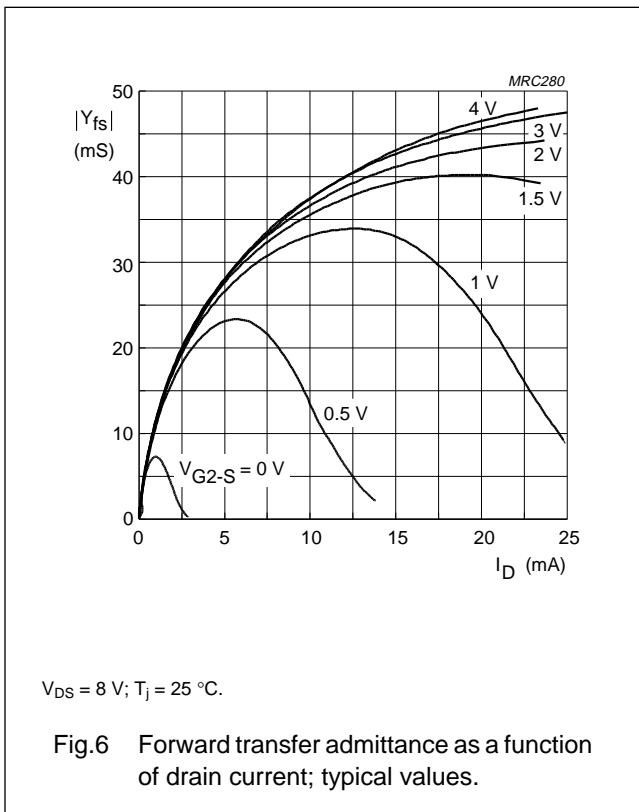
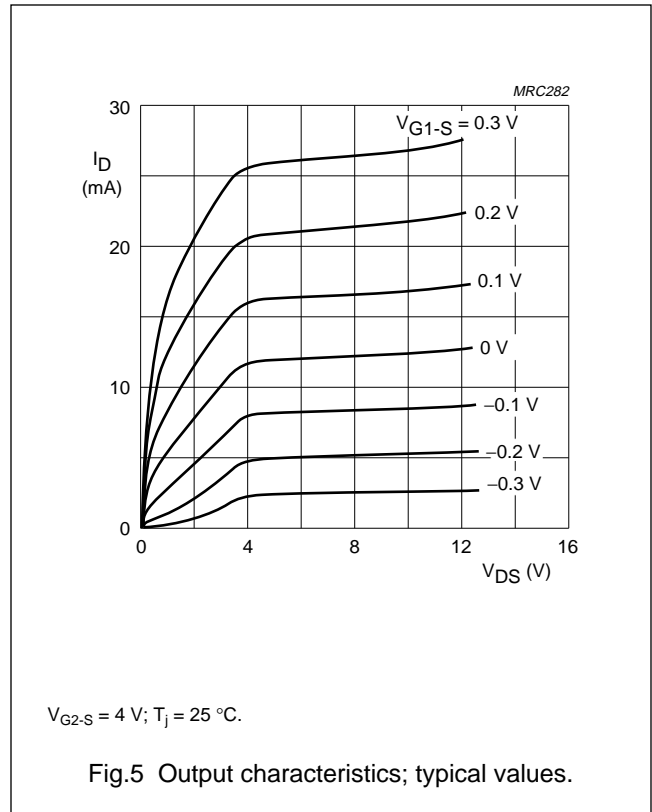
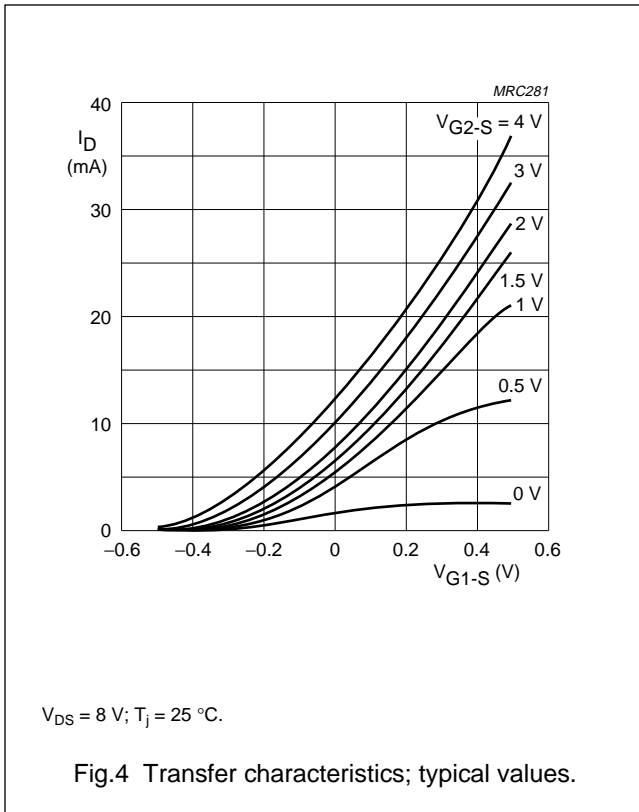

Dual-gate MOS-FETs

BF908; BF908R

Table 1 Scattering parameters

f (MHz)	S ₁₁		S ₂₁		S ₁₂		S ₂₂	
	MAGNITUDE (ratio)	ANGLE (deg)	MAGNITUDE (ratio)	ANGLE (deg)	MAGNITUDE (ratio)	ANGLE (deg)	MAGNITUDE (ratio)	ANGLE (deg)
V_{DS} = 8 V; V_{G2-S} = 4 V; I_D = 10 mA; T_{amb} = 25 °C.								
50	0.998	-5.1	3.537	173.5	0.001	98.2	0.996	-2.4
100	0.994	-10.4	3.502	167.7	0.001	88.8	0.994	-4.9
200	0.979	-20.8	3.450	154.9	0.003	74.6	0.987	-9.5
300	0.962	-30.3	3.318	143.7	0.004	69.5	0.983	-13.9
400	0.939	-40.1	3.234	131.9	0.005	65.6	0.980	-18.5
500	0.914	-49.1	3.093	120.7	0.006	64.4	0.974	-22.8
600	0.892	-57.1	2.912	111.1	0.005	63.1	0.969	-27.0
700	0.865	-64.4	2.774	101.0	0.005	65.2	0.966	-31.2
800	0.837	-71.6	2.616	91.4	0.004	70.8	0.965	-35.4
900	0.811	-78.1	2.479	81.9	0.004	87.4	0.965	-39.4
1000	0.785	-84.5	3.329	72.5	0.003	108.0	0.966	-43.7
V_{DS} = 8 V; V_{G2-S} = 4 V; I_D = 15 mA; T_{amb} = 25 °C.								
50	0.998	-5.3	3.983	173.4	0.001	95.5	0.994	-2.4
100	0.994	-10.9	3.943	167.5	0.001	93.6	0.991	-5.0
200	0.976	-21.6	3.878	154.7	0.003	74.3	0.984	-9.7
300	0.957	-31.7	3.722	143.3	0.004	70.0	0.979	-14.2
400	0.934	-41.7	3.614	131.6	0.005	63.5	0.975	-18.8
500	0.907	-51.1	3.446	120.4	0.006	62.2	0.969	-23.2
600	0.885	-59.1	3.240	110.9	0.005	59.6	0.964	-27.4
700	0.851	-66.8	3.072	100.9	0.005	64.8	0.961	-31.6
800	0.826	-73.9	2.891	91.3	0.004	67.8	0.959	-35.9
900	0.797	-80.7	2.733	81.9	0.004	85.0	0.958	-40.0
1000	0.773	-87.0	2.569	72.8	0.004	102.9	0.958	-44.2

Table 2 Noise data

f (MHz)	F _{min} (dB)	Γ _{opt}		r _n
		(ratio)	(deg)	
V_{DS} = 8 V; V_{G2-S} = 4 V; I_D = 10 mA; T_{amb} = 25 °C.				
800	1.50	0.720	56.7	0.580
V_{DS} = 8 V; V_{G2-S} = 4 V; I_D = 15 mA; T_{amb} = 25 °C.				
800	1.50	0.700	59.2	0.520

Dual-gate MOS-FETs

BF908; BF908R

PACKAGE OUTLINES

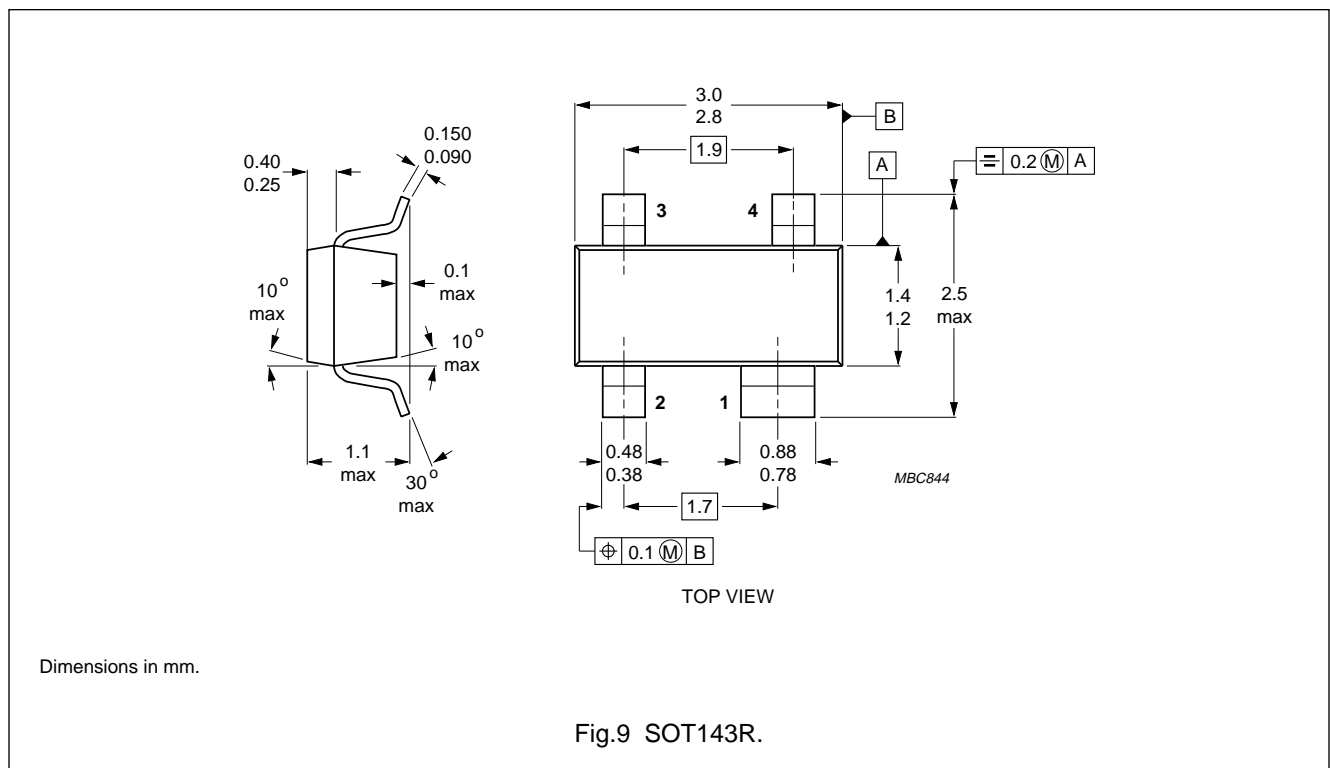
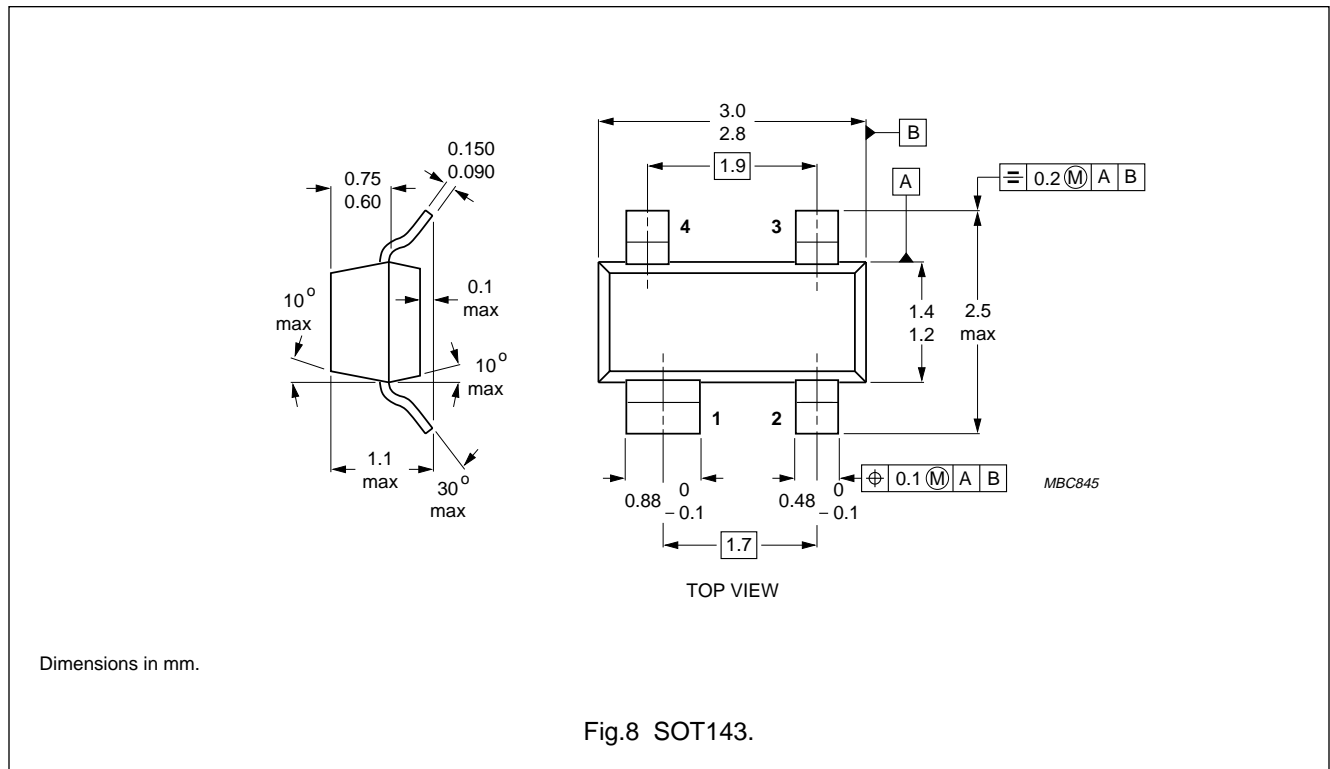

Dual-gate MOS-FETs

BF908; BF908R

DEFINITIONS

Data Sheet Status	
Objective specification	This data sheet contains target or goal specifications for product development.
Preliminary specification	This data sheet contains preliminary data; supplementary data may be published later.
Product specification	This data sheet contains final product specifications.
Limiting values	
Limiting values given are in accordance with the Absolute Maximum Rating System (IEC 134). Stress above one or more of the limiting values may cause permanent damage to the device. These are stress ratings only and operation of the device at these or at any other conditions above those given in the Characteristics sections of the specification is not implied. Exposure to limiting values for extended periods may affect device reliability.	
Application information	
Where application information is given, it is advisory and does not form part of the specification.	

LIFE SUPPORT APPLICATIONS

These products are not designed for use in life support appliances, devices, or systems where malfunction of these products can reasonably be expected to result in personal injury. Philips customers using or selling these products for use in such applications do so at their own risk and agree to fully indemnify Philips for any damages resulting from such improper use or sale.