

February 1996

40A, 600V, UFS Series N-Channel IGBT

## Features

- 40A, 600V at  $T_C = +25^\circ\text{C}$
- Square Switching SOA Capability
- Typical Fall Time - 140ns at  $+150^\circ\text{C}$
- Short Circuit Rated
- Low Conduction Loss

## Description

The HGTP20N60B3 and the HGTG20N60B3 are Generation 3 MOS gated high voltage switching devices combining the best features of MOSFETs and bipolar transistors. These devices have the high input impedance of a MOSFET and the low on-state conduction loss of a bipolar transistor. The much lower on-state voltage drop varies only moderately between  $+25^\circ\text{C}$  and  $+150^\circ\text{C}$ .

The IGBT is ideal for many high voltage switching applications operating at moderate frequencies where low conduction losses are essential, such as: AC and DC motor controls, power supplies and drivers for solenoids, relays and contactors.

### PACKAGING AVAILABILITY

| PART NUMBER | PACKAGE  | BRAND    |
|-------------|----------|----------|
| HGTP20N60B3 | TO-220AB | G20N60B3 |
| HGTG20N60B3 | TO-247   | G20N60B3 |

NOTE: When ordering, use the entire part number.

Formerly Developmental Type TA49050.

## Package

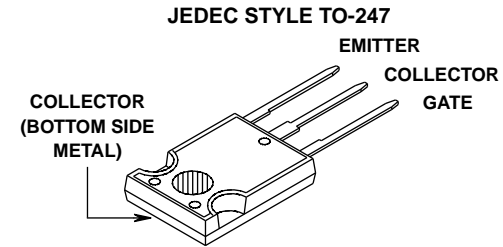
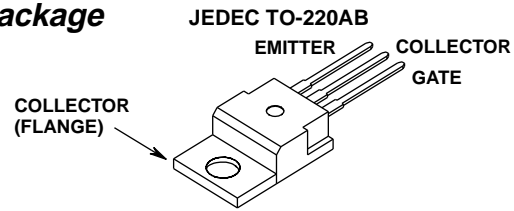

## Terminal Diagram

N-CHANNEL ENHANCEMENT MODE

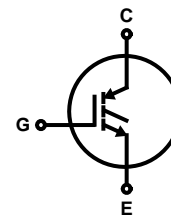

## Absolute Maximum Ratings $T_C = +25^\circ\text{C}$ , Unless Otherwise Specified

|   | HGTP20N60B3<br>HGTG20N60B3 | UNITS               |
|---|----------------------------|---------------------|
| Collector-Emitter Voltage                                   | 600                        | V                   |
| Collector-Gate Voltage, $R_{GE} = 1M\Omega$                 | 600                        | V                   |
| Collector Current Continuous                                |                            |                     |
| At $T_C = +25^\circ\text{C}$                                | 40                         | A                   |
| At $T_C = +110^\circ\text{C}$                               | 20                         | A                   |
| Collector Current Pulsed (Note 1)                           | 160                        | A                   |
| Gate-Emitter Voltage Continuous                             | $\pm 20$                   | V                   |
| Gate-Emitter Voltage Pulsed                                 | $\pm 30$                   | V                   |
| Switching Safe Operating Area at $T_C = +150^\circ\text{C}$ | 80A at 0.8 $BV_{CES}$      |                     |
| Power Dissipation Total at $T_C = +25^\circ\text{C}$        | 165                        | W                   |
| Power Dissipation Derating $T_C > +25^\circ\text{C}$        | 1.32                       | W/ $^\circ\text{C}$ |
| Operating and Storage Junction Temperature Range            | -40 to +150                | $^\circ\text{C}$    |
| Maximum Lead Temperature for Soldering                      | 260                        | $^\circ\text{C}$    |
| Short Circuit Withstand Time (Note 2) at $V_{GE} = 15V$     | 4                          | $\mu\text{s}$       |
| Short Circuit Withstand Time (Note 2) at $V_{GE} = 10V$     | 10                         | $\mu\text{s}$       |

NOTE:

1. Repetitive Rating: Pulse width limited by maximum junction temperature.
2.  $V_{CE(PK)} = 360V$ ,  $T_C = +125^\circ\text{C}$ ,  $R_{GE} = 25\Omega$ .

### HARRIS SEMICONDUCTOR IGBT PRODUCT IS COVERED BY ONE OR MORE OF THE FOLLOWING U.S. PATENTS:

|           |           |           |           |           |           |           |           |
|-----------|-----------|-----------|-----------|-----------|-----------|-----------|-----------|
| 4,364,073 | 4,417,385 | 4,430,792 | 4,443,931 | 4,466,176 | 4,516,143 | 4,532,534 | 4,567,641 |
| 4,587,713 | 4,598,461 | 4,605,948 | 4,618,872 | 4,620,211 | 4,631,564 | 4,639,754 | 4,639,762 |
| 4,641,162 | 4,644,637 | 4,682,195 | 4,684,413 | 4,694,313 | 4,717,679 | 4,743,952 | 4,783,690 |
| 4,794,432 | 4,801,986 | 4,803,533 | 4,809,045 | 4,809,047 | 4,810,665 | 4,823,176 | 4,837,606 |
| 4,860,080 | 4,883,767 | 4,888,627 | 4,890,143 | 4,901,127 | 4,904,609 | 4,933,740 | 4,963,951 |
| 4,969,027 |           |           |           |           |           |           |           |

## Specifications HGTP20N60B3, HGTG20N60B3

### Electrical Specifications $T_C = +25^\circ\text{C}$ , Unless Otherwise Specified

| PARAMETERS                           | SYMBOL          | TEST CONDITIONS  | LIMITS                     |      |           | UNITS              |               |
|--------------------------------------|-----------------|--|----------------------------|------|-----------|--------------------|---------------|
|                                      |                 |  | MIN                        | TYP  | MAX       |                    |               |
| Collector-Emitter Breakdown Voltage  | $BV_{CES}$      | $I_C = 250\mu\text{A}$ , $V_{GE} = 0\text{V}$  | 600                        | -    | -         | V                  |               |
| Collector-Emitter Leakage Current    | $I_{CES}$       | $V_{CE} = BV_{CES}$  | $T_C = +25^\circ\text{C}$  | -    | -         | 250                | $\mu\text{A}$ |
|                                      |                 | $V_{CE} = BV_{CES}$  | $T_C = +150^\circ\text{C}$ | -    | -         | 1.0                | $\text{mA}$   |
| Collector-Emitter Saturation Voltage | $V_{CE(SAT)}$   | $I_C = I_{C110}$ ,<br>$V_{GE} = 15\text{V}$  | $T_C = +25^\circ\text{C}$  | -    | 1.8       | 2.0                | V             |
|                                      |                 |  | $T_C = +150^\circ\text{C}$ | -    | 2.1       | 2.5                | V             |
| Gate-Emitter Threshold Voltage       | $V_{GE(TH)}$    | $I_C = 250\mu\text{A}$ ,<br>$V_{CE} = V_{GE}$  | $T_C = +25^\circ\text{C}$  | 3.0  | 5.0       | 6.0                | V             |
| Gate-Emitter Leakage Current         | $I_{GES}$       | $V_{GE} = \pm 20\text{V}$  | -                          | -    | $\pm 100$ | $\text{nA}$        |               |
| Latching Current                     | $I_L$           | $T_C = +150^\circ\text{C}$<br>$V_{CE(PK)} = 0.8 BV_{CES}$<br>$V_{GE} = 15\text{V}$<br>$R_G = 10\Omega$<br>$L = 45\mu\text{H}$                        | 80                         | -    | -         | A                  |               |
| Gate-Emitter Plateau Voltage         | $V_{GEP}$       | $I_C = I_{C110}$ , $V_{CE} = 0.5 BV_{CES}$   | -                          | 8.0  | -         | V                  |               |
| On-State Gate Charge                 | $Q_{G(ON)}$     | $I_C = I_{C110}$ ,<br>$V_{CE} = 0.5 BV_{CES}$  | $V_{GE} = 15\text{V}$      | -    | 80        | 105                | $\text{nC}$   |
|                                      |                 |  | $V_{GE} = 20\text{V}$      | -    | 105       | 135                | $\text{nC}$   |
| Current Turn-On Delay Time           | $t_{D(ON)I}$    | $T_C = 150^\circ\text{C}$<br>$I_{CE} = I_{C110}$<br>$V_{CE(PK)} = 0.8 BV_{CES}$<br>$V_{GE} = 15\text{V}$<br>$R_G = 10\Omega$<br>$L = 100\mu\text{H}$ | -                          | 25   | -         | $\text{ns}$        |               |
| Current Rise Time                    | $t_{RI}$        |  | -                          | 20   | -         | $\text{ns}$        |               |
| Current Turn-Off Delay Time          | $t_{D(OFF)I}$   |  | -                          | 220  | 275       | $\text{ns}$        |               |
| Current Fall Time                    | $t_{FI}$        |  | -                          | 140  | 200       | $\text{ns}$        |               |
| Turn-On Energy                       | $E_{ON}$        |  | -                          | 475  | -         | $\mu\text{J}$      |               |
| Turn-Off Energy (Note 1)             | $E_{OFF}$       |  | -                          | 1050 | -         | $\mu\text{J}$      |               |
| Thermal Resistance                   | $R_{\theta JC}$ |  | -                          | -    | 0.76      | $^\circ\text{C/W}$ |               |

**NOTE:**

1. Turn-Off Energy Loss ( $E_{OFF}$ ) is defined as the integral of the instantaneous power loss starting at the trailing edge of the input pulse and ending at the point where the collector current equals zero ( $I_{CE} = 0\text{A}$ ). The HGTP20N60B3 and HGTG20N60B3 were tested per JEDEC standard No. 24-1 Method for Measurement of Power Device Turn-Off Switching Loss. This test method produces the true total Turn-Off Energy Loss. Turn-on losses include diode losses.

Typical Performance Curves

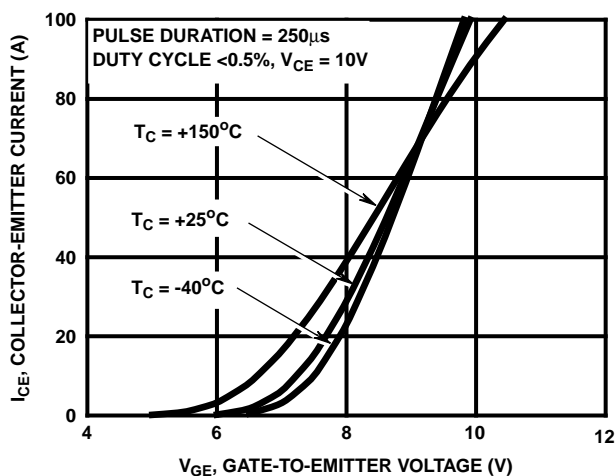

FIGURE 1. TRANSFER CHARACTERISTICS

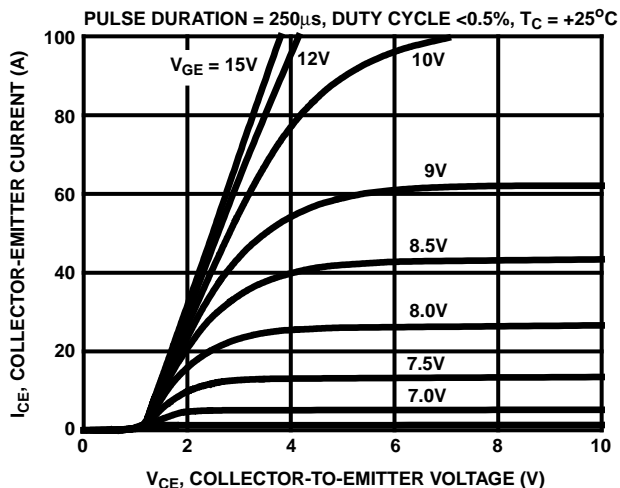

FIGURE 2. SATURATION CHARACTERISTICS

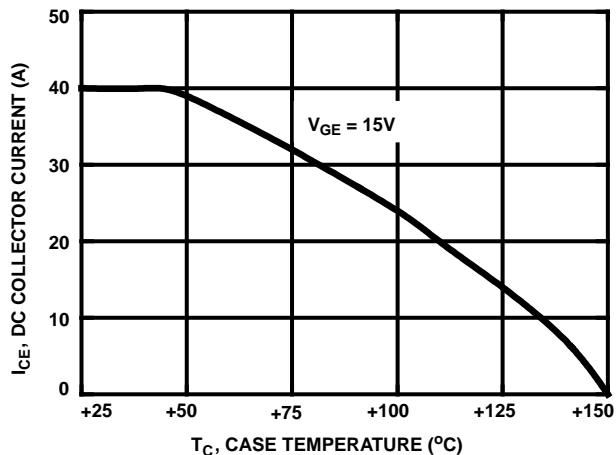

FIGURE 3. DC COLLECTOR CURRENT vs CASE TEMPERATURE

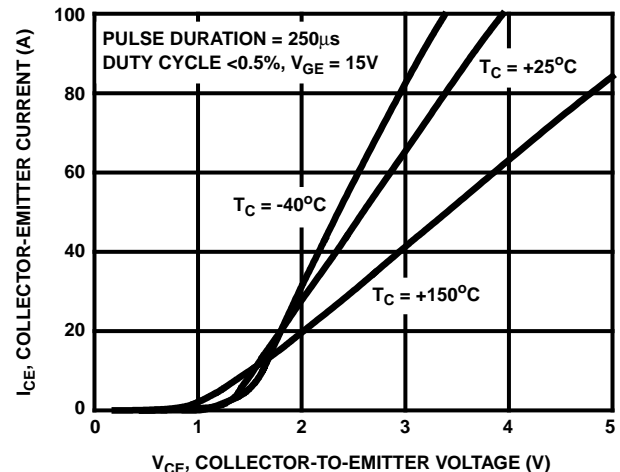

FIGURE 4. COLLECTOR-EMITTER ON - STATE VOLTAGE

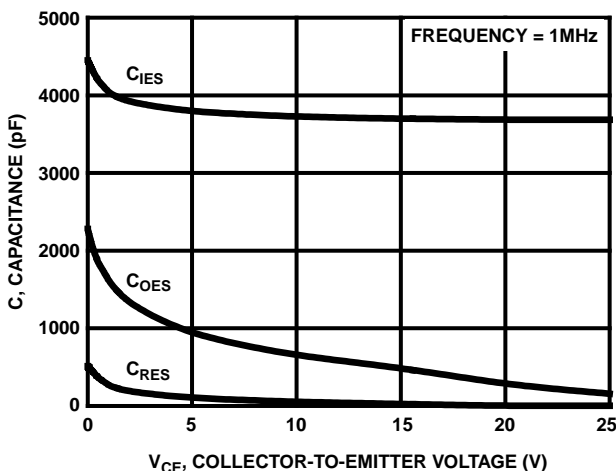

FIGURE 5. CAPACITANCE vs COLLECTOR-EMITTER VOLTAGE

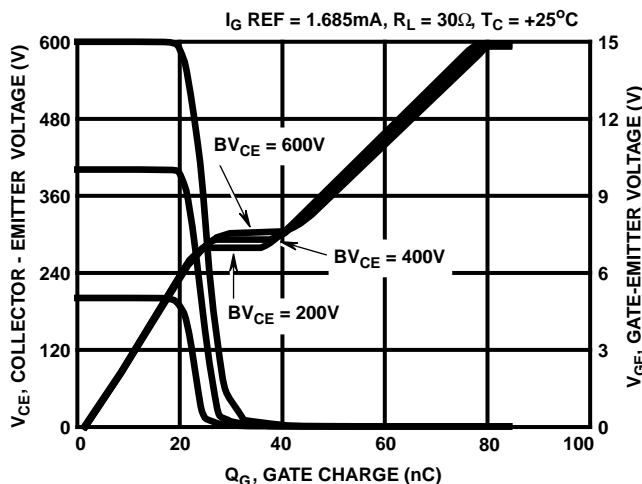

FIGURE 6. GATE CHARGE WAVEFORMS

Typical Performance Curves (Continued)

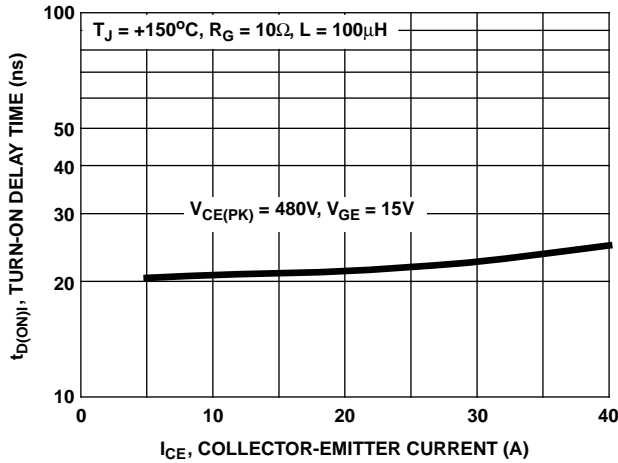

FIGURE 7. TURN-ON DELAY TIME AS A FUNCTION OF COLLECTOR-EMITTER CURRENT

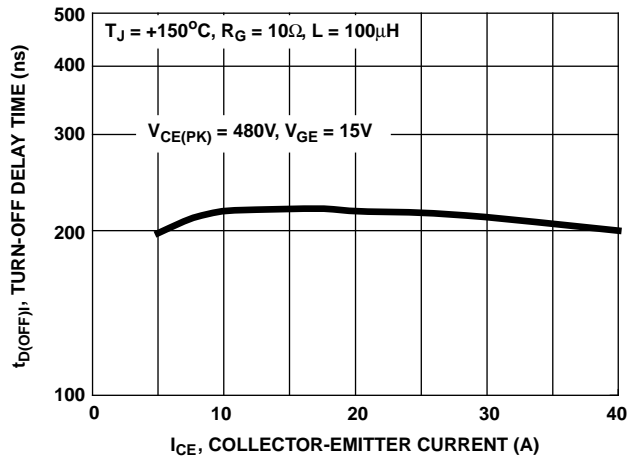

FIGURE 8. TURN-OFF DELAY TIME AS A FUNCTION OF COLLECTOR-EMITTER CURRENT

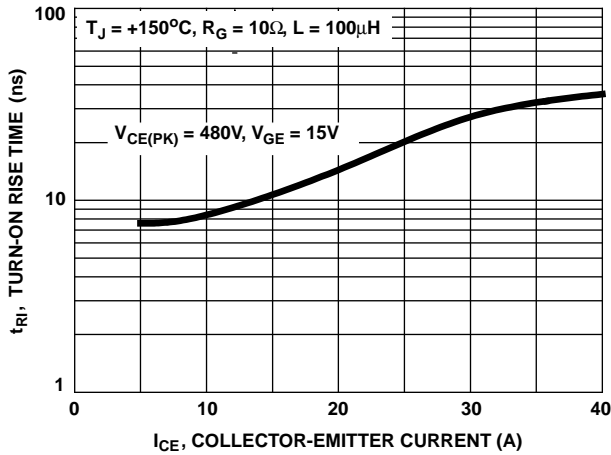

FIGURE 9. TURN-ON RISE TIME AS A FUNCTION OF COLLECTOR-EMITTER CURRENT

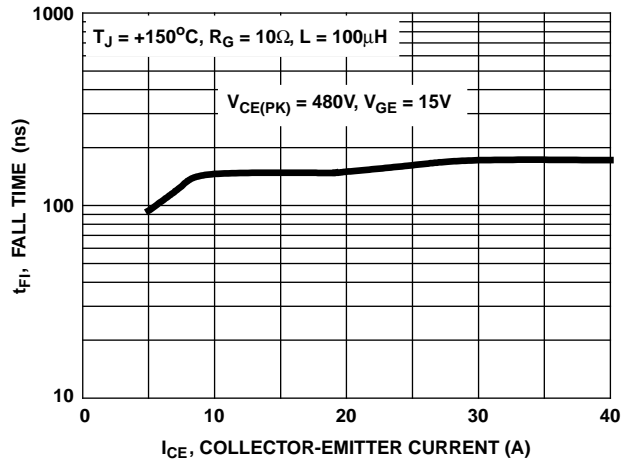

FIGURE 10. TURN-OFF FALL TIME AS A FUNCTION OF COLLECTOR-EMITTER CURRENT

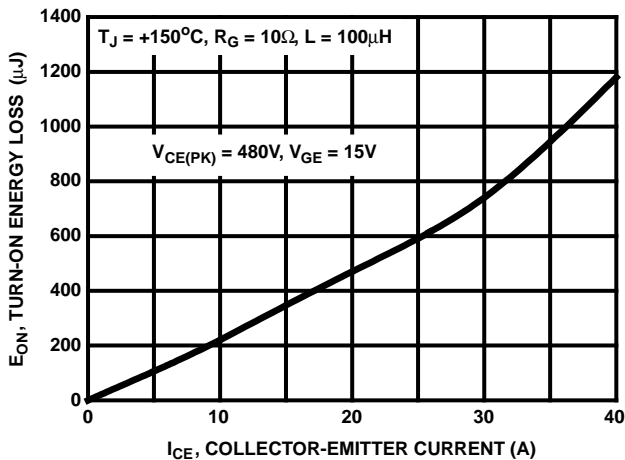

FIGURE 11. TURN-ON ENERGY LOSS AS A FUNCTION OF COLLECTOR-EMITTER CURRENT

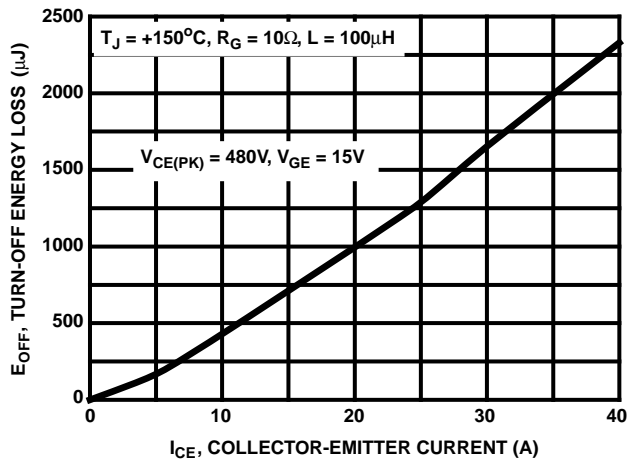

FIGURE 12. TURN-OFF ENERGY LOSS AS A FUNCTION OF COLLECTOR-EMITTER CURRENT

Typical Performance Curves (Continued)

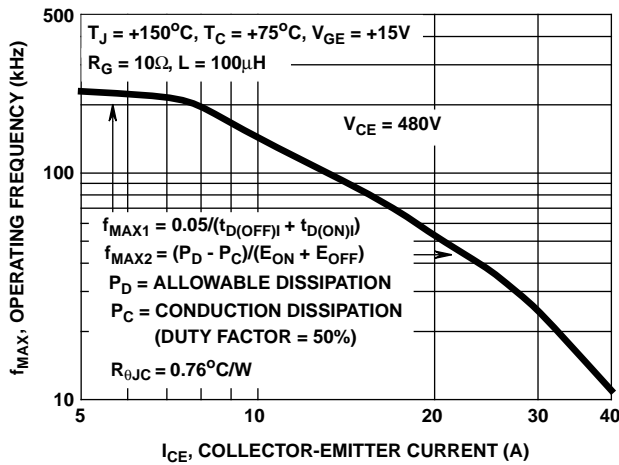

FIGURE 13. OPERATING FREQUENCY AS A FUNCTION OF COLLECTOR-EMITTER CURRENT

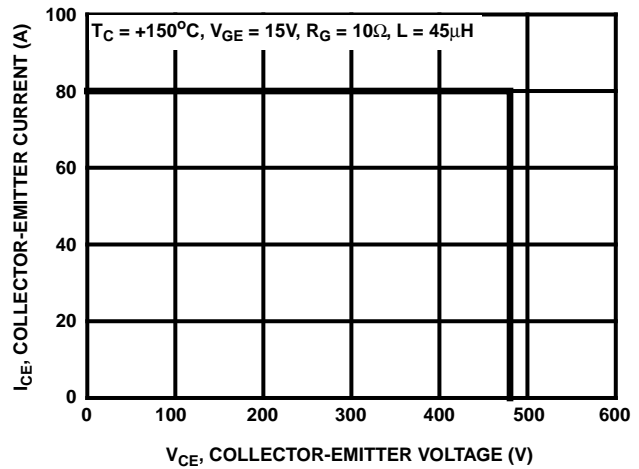

FIGURE 14. SWITCHING SAFE OPERATING AREA

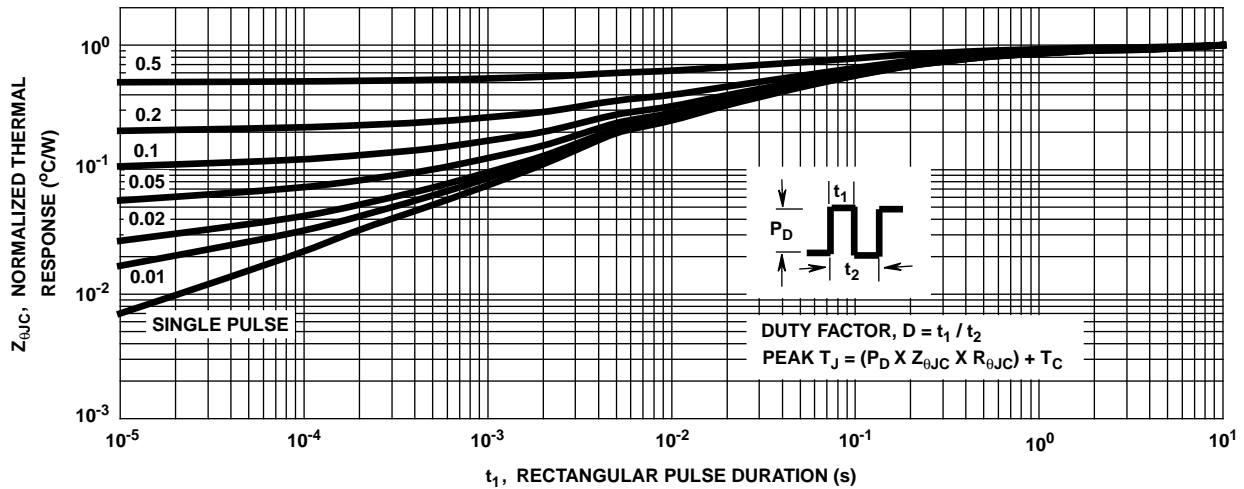

FIGURE 15. IGBT NORMALIZED TRANSIENT THERMAL IMPEDANCE, JUNCTION TO CASE

Operating Frequency Information

Operating frequency information for a typical device (Figure 13) is presented as a guide for estimating device performance for a specific application. Other typical frequency vs collector current ( $I_{CE}$ ) plots are possible using the information shown for a typical unit in Figures 4, 7, 8, 11 and 12. The operating frequency plot (Figure 13) of a typical device shows  $f_{MAX1}$  or  $f_{MAX2}$  whichever is smaller at each point. The information is based on measurements of a typical device and is bounded by the maximum rated junction temperature.

$f_{MAX1}$  is defined by  $f_{MAX1} = 0.05/(t_{D(OFF)I} + t_{D(ON)I})$ . Deadtime (the denominator) has been arbitrarily held to 10% of the on-state time for a 50% duty factor. Other definitions are possible.  $t_{D(OFF)I}$  and  $t_{D(ON)I}$  are defined in Figure 17.

Device turn-off delay can establish an additional frequency limiting condition for an application other than  $T_{JMAX} \cdot t_{D(OFF)I}$  is important when controlling output ripple under a lightly loaded condition.

$f_{MAX2}$  is defined by  $f_{MAX2} = (P_D - P_C)/(E_{OFF} + E_{ON})$ . The allowable dissipation ( $P_D$ ) is defined by  $P_D = (T_{JMAX} - T_C)/R_{\theta JC}$ .

The sum of device switching and conduction losses must not exceed  $P_D$ . A 50% duty factor was used (Figure 13) and the conduction losses ( $P_C$ ) are approximated by  $P_C = (V_{CE} \times I_{CE})/2$ .

$E_{ON}$  and  $E_{OFF}$  are defined in the switching waveforms shown in Figure 17.  $E_{ON}$  is the integral of the instantaneous power loss ( $I_{CE} \times V_{CE}$ ) during turn-on and  $E_{OFF}$  is the integral of the instantaneous power loss ( $I_{CE} \times V_{CE}$ ) during turn-off. All tail losses are included in the calculation for  $E_{OFF}$ ; i.e. the collector current equals zero ( $I_{CE} = 0$ ).

**Test Circuit**

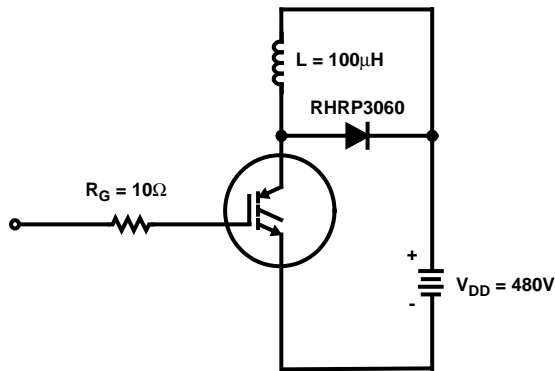

FIGURE 16. INDUCTIVE SWITCHING TEST CIRCUIT

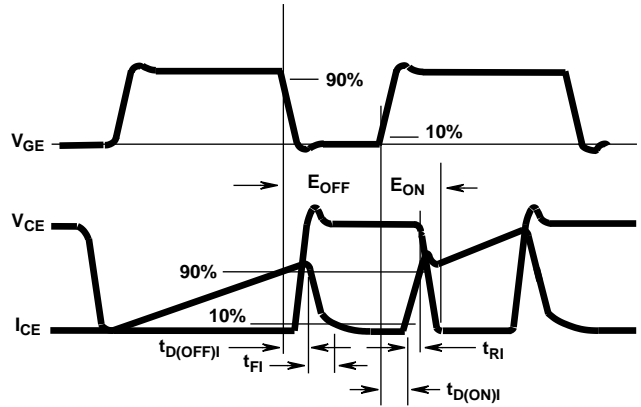

FIGURE 17. SWITCHING TEST WAVEFORMS

**Handling Precautions for IGBTs**

Insulated Gate Bipolar Transistors are susceptible to gate-insulation damage by the electrostatic discharge of energy through the devices. When handling these devices, care should be exercised to assure that the static charge built in the handler's body capacitance is not discharged through the device. With proper handling and application procedures, however, IGBT's are currently being extensively used in production by numerous equipment manufacturers in military, industrial and consumer applications, with virtually no damage problems due to electrostatic discharge. IGBTs can be handled safely if the following basic precautions are taken:

1. Prior to assembly into a circuit, all leads should be kept shorted together either by the use of metal shorting springs or by the insertion into conductive material such as "ECCOSORBD™ LD26" or equivalent.
2. When devices are removed by hand from their carriers, the hand being used should be grounded by any suitable means - for example, with a metallic wristband.
3. Tips of soldering irons should be grounded.
4. Devices should never be inserted into or removed from circuits with power on.
5. **Gate Voltage Rating** - Never exceed the gate-voltage rating of  $V_{GEM}$ . Exceeding the rated  $V_{GE}$  can result in permanent damage to the oxide layer in the gate region.
6. **Gate Termination** - The gates of these devices are essentially capacitors. Circuits that leave the gate open-circuited or floating should be avoided. These conditions can result in turn-on of the device due to voltage buildup on the input capacitor due to leakage currents or pickup.
7. **Gate Protection** - These devices do not have an internal monolithic zener diode from gate to emitter. If gate protection is required an external zener is recommended.

# HGTP20N60B3, HGTG20N60B3

## Packaging

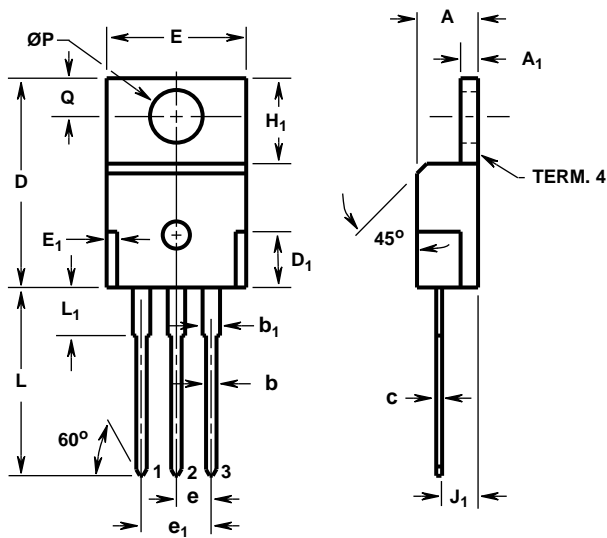

- LEAD 1 - GATE
- LEAD 2 - COLLECTOR
- LEAD 3 - EMITTER
- TERM. 4 - COLLECTOR

## TO-220AB

### 3 LEAD JEDEC TO-220AB PLASTIC PACKAGE

| SYMBOL          | INCHES    |       | MILLIMETERS |       | NOTES   |
|-----------------|-----------|-------|-------------|-------|---------|
|                 | MIN       | MAX   | MIN         | MAX   |         |
| A               | 0.170     | 0.180 | 4.32        | 4.57  | -       |
| A <sub>1</sub>  | 0.048     | 0.052 | 1.22        | 1.32  | -       |
| b               | 0.030     | 0.034 | 0.77        | 0.86  | 3, 4    |
| b <sub>1</sub>  | 0.045     | 0.055 | 1.15        | 1.39  | 2, 3    |
| c               | 0.014     | 0.019 | 0.36        | 0.48  | 2, 3, 4 |
| D               | 0.590     | 0.610 | 14.99       | 15.49 | -       |
| D <sub>1</sub>  | -         | 0.160 | -           | 4.06  | -       |
| E               | 0.395     | 0.410 | 10.04       | 10.41 | -       |
| E <sub>1</sub>  | -         | 0.030 | -           | 0.76  | -       |
| e               | 0.100 TYP |       | 2.54 TYP    |       | 5       |
| e <sub>1</sub>  | 0.200 BSC |       | 5.08 BSC    |       | 5       |
| H <sub>1</sub>  | 0.235     | 0.255 | 5.97        | 6.47  | -       |
| J <sub>1</sub>  | 0.100     | 0.110 | 2.54        | 2.79  | 6       |
| L               | 0.530     | 0.550 | 13.47       | 13.97 | -       |
| L <sub>1</sub>  | 0.130     | 0.150 | 3.31        | 3.81  | 2       |
| $\varnothing P$ | 0.149     | 0.153 | 3.79        | 3.88  | -       |
| Q               | 0.102     | 0.112 | 2.60        | 2.84  | -       |

#### NOTES:

1. These dimensions are within allowable dimensions of Rev. J of JEDEC TO-220AB outline dated 3-24-87.
2. Lead dimension and finish uncontrolled in L<sub>1</sub>.
3. Lead dimension (without solder).
4. Add typically 0.002 inches (0.05mm) for solder coating.
5. Position of lead to be measured 0.250 inches (6.35mm) from bottom of dimension D.
6. Position of lead to be measured 0.100 inches (2.54mm) from bottom of dimension D.
7. Controlling dimension: Inch.
8. Revision 1 dated 1-93.

# HGTP20N60B3, HGTG20N60B3

## Packaging (Continued)

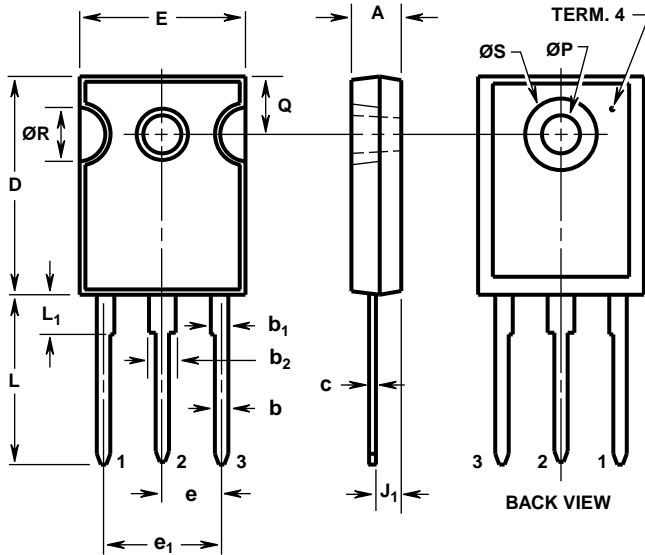

- LEAD 1 - GATE
- LEAD 2 - COLLECTOR
- LEAD 3 - EMITTER
- TERM. 4 - COLLECTOR

## TO-247

### 3 LEAD JEDEC STYLE TO-247 PLASTIC PACKAGE

| SYMBOL         | INCHES    |       | MILLIMETERS |       | NOTES   |
|----------------|-----------|-------|-------------|-------|---------|
|                | MIN       | MAX   | MIN         | MAX   |         |
| A              | 0.180     | 0.190 | 4.58        | 4.82  | -       |
| b              | 0.046     | 0.051 | 1.17        | 1.29  | 2, 3    |
| b <sub>1</sub> | 0.060     | 0.070 | 1.53        | 1.77  | 1, 2    |
| b <sub>2</sub> | 0.095     | 0.105 | 2.42        | 2.66  | 1, 2    |
| c              | 0.020     | 0.026 | 0.51        | 0.66  | 1, 2, 3 |
| D              | 0.800     | 0.820 | 20.32       | 20.82 | -       |
| E              | 0.605     | 0.625 | 15.37       | 15.87 | -       |
| e              | 0.219 TYP |       | 5.56 TYP    |       | 4       |
| e <sub>1</sub> | 0.438 BSC |       | 11.12 BSC   |       | 4       |
| J <sub>1</sub> | 0.090     | 0.105 | 2.29        | 2.66  | 5       |
| L              | 0.620     | 0.640 | 15.75       | 16.25 | -       |
| L <sub>1</sub> | 0.145     | 0.155 | 3.69        | 3.93  | 1       |
| ØP             | 0.138     | 0.144 | 3.51        | 3.65  | -       |
| Q              | 0.210     | 0.220 | 5.34        | 5.58  | -       |
| ØR             | 0.195     | 0.205 | 4.96        | 5.20  | -       |
| ØS             | 0.260     | 0.270 | 6.61        | 6.85  | -       |

#### NOTES:

1. Lead dimension and finish uncontrolled in L<sub>1</sub>.
2. Lead dimension (without solder).
3. Add typically 0.002 inches (0.05mm) for solder coating.
4. Position of lead to be measured 0.250 inches (6.35mm) from bottom of dimension D.
5. Position of lead to be measured 0.100 inches (2.54mm) from bottom of dimension D.
6. Controlling dimension: Inch.
7. Revision 1 dated 1-93.

All Harris Semiconductor products are manufactured, assembled and tested under **ISO9000** quality systems certification.

*Harris Semiconductor products are sold by description only. Harris Semiconductor reserves the right to make changes in circuit design and/or specifications at any time without notice. Accordingly, the reader is cautioned to verify that data sheets are current before placing orders. Information furnished by Harris is believed to be accurate and reliable. However, no responsibility is assumed by Harris or its subsidiaries for its use; nor for any infringements of patents or other rights of third parties which may result from its use. No license is granted by implication or otherwise under any patent or patent rights of Harris or its subsidiaries.*

## Sales Office Headquarters

For general information regarding Harris Semiconductor and its products, call **1-800-4-HARRIS**

### NORTH AMERICA

Harris Semiconductor  
P. O. Box 883, Mail Stop 53-210  
Melbourne, FL 32902  
TEL: 1-800-442-7747  
(407) 729-4984  
FAX: (407) 729-5321

### EUROPE

Harris Semiconductor  
Mercure Center  
100, Rue de la Fusee  
1130 Brussels, Belgium  
TEL: (32) 2.724.2111  
FAX: (32) 2.724.22.05

### ASIA

Harris Semiconductor PTE Ltd.  
No. 1 Tannery Road  
Cencon 1, #09-01  
Singapore 1334  
TEL: (65) 748-4200  
FAX: (65) 748-0400

