

Darlington Complementary Silicon Power Transistors

... designed for general-purpose amplifier and low-speed switching motor control applications.

- Similar to the Popular NPN 2N6282, 2N6283, 2N6284 and the PNP 2N6285, 2N6286, 2N6287
- Rugged RBSOA Characteristics
- Monolithic Construction with Built-in Collector-Emitter Diode

NPN
MJH6282
MJH6283*
MJH6284*
PNP
MJH6285
MJH6286*
MJH6287*

*Motorola Preferred Device

DARLINGTON
20 AMPERE
COMPLEMENTARY SILICON
POWER TRANSISTORS
60, 80, 100 VOLTS
160 WATTS

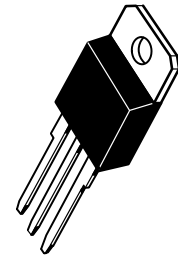

CASE 340D-01

MAXIMUM RATINGS

Rating	Symbol	MJH6282 MJH6285	MJH6283 MJH6286	MJH6284 MJH6287	Unit
Collector-Emitter Voltage	V_{CEO}	60	80	100	Vdc
Collector-Base Voltage	V_{CB}	60	80	100	Vdc
Emitter-Base Voltage	V_{EB}	5.0			Vdc
Collector Current — Continuous Peak	I_C	20 40			Adc
Base Current	I_B	0.5			Adc
Total Device Dissipation @ $T_C = 25^\circ\text{C}$ Derate above 25°C	P_D	160 1.28			Watts W/ $^\circ\text{C}$
Operating and Storage Junction Temperature Range	T_J, T_{stg}	-65 to +150			$^\circ\text{C}$

THERMAL CHARACTERISTICS

Characteristic	Symbol	Max	Unit
Thermal Resistance, Junction to Case	$R_{\theta JC}$	0.78	$^\circ\text{C/W}$

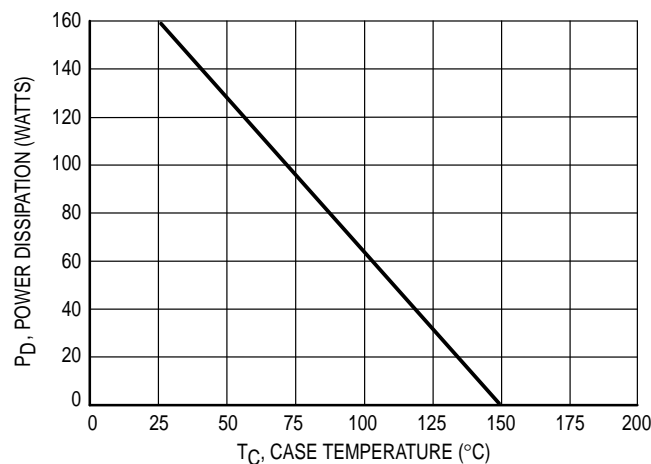

Figure 1. Power Derating

Preferred devices are Motorola recommended choices for future use and best overall value.

MJH6282 MJH6283 MJH6284 MJH6285 MJH6286 MJH6287

ELECTRICAL CHARACTERISTICS ($T_C = 25^\circ\text{C}$ unless otherwise noted)

Characteristic	Symbol	Min	Max	Unit
OFF CHARACTERISTICS				
Collector–Emitter Sustaining Voltage ($I_C = 0.1\text{ A dc}$, $I_B = 0$)	$V_{CE(sus)}$	60 80 100	—	Vdc
Collector Cutoff Current ($V_{CE} = 30\text{ Vdc}$, $I_B = 0$) ($V_{CE} = 40\text{ Vdc}$, $I_B = 0$) ($V_{CE} = 50\text{ Vdc}$, $I_B = 0$)	I_{CEO}	— — —	1.0 1.0 1.0	mAdc
Collector Cutoff Current ($V_{CE} = \text{Rated } V_{CB}$, $V_{BE(off)} = 1.5\text{ Vdc}$) ($V_{CE} = \text{Rated } V_{CB}$, $V_{BE(off)} = 1.5\text{ Vdc}$, $T_C = 150^\circ\text{C}$)	I_{CEX}	— —	0.5 5.0	mAdc
Emitter Cutoff Current ($V_{BE} = 5.0\text{ Vdc}$, $I_C = 0$)	I_{EBO}	—	2.0	mAdc

ON CHARACTERISTICS (1)

DC Current Gain ($I_C = 10\text{ A dc}$, $V_{CE} = 3.0\text{ Vdc}$) ($I_C = 20\text{ A dc}$, $V_{CE} = 3.0\text{ Vdc}$)	h_{FE}	750 100	18,000 —	—
Collector–Emitter Saturation Voltage ($I_C = 10\text{ A dc}$, $I_B = 40\text{ mA dc}$) ($I_C = 20\text{ A dc}$, $I_B = 200\text{ mA dc}$)	$V_{CE(sat)}$	— —	2.0 3.0	Vdc
Base–Emitter On Voltage ($I_C = 10\text{ A dc}$, $V_{CE} = 3.0\text{ Vdc}$)	$V_{BE(on)}$	—	2.8	Vdc
Base–Emitter Saturation Voltage ($I_C = 20\text{ A dc}$, $I_B = 200\text{ mA dc}$)	$V_{BE(sat)}$	—	4.0	Vdc

DYNAMIC CHARACTERISTICS

Current–Gain Bandwidth Product ($I_C = 10\text{ A dc}$, $V_{CE} = 3.0\text{ Vdc}$, $f = 1.0\text{ MHz}$)	f_T	4.0	—	MHz
Output Capacitance ($V_{CB} = 10\text{ Vdc}$, $I_E = 0$, $f = 0.1\text{ MHz}$)	C_{ob}	— —	400 600	pF
Small–Signal Current Gain ($I_C = 10\text{ A dc}$, $V_{CE} = 3.0\text{ Vdc}$, $f = 1.0\text{ kHz}$)	h_{fe}	300	—	—

SWITCHING CHARACTERISTICS

Resistive Load		Symbol	Typical		Unit
			NPN	PNP	
Delay Time	$V_{CC} = 30\text{ Vdc}$, $I_C = 10\text{ A dc}$ $I_{B1} = I_{B2} = 100\text{ mA}$ Duty Cycle = 1.0%	t_d	0.1	0.1	μs
Rise Time		t_r	0.3	0.3	
Storage Time		t_s	1.0	1.0	
Fall Time		t_f	3.5	2.0	

(1) Pulse test: Pulse Width = 300 μs , Duty Cycle = 2.0%.

R_B & R_C VARIED TO OBTAIN DESIRED CURRENT LEVELS

D_1 , MUST BE FAST RECOVERY TYPES, e.g.:

1N5825 USED ABOVE $I_B \approx 100\text{ mA}$

MSD6100 USED BELOW $I_B \approx 100\text{ mA}$

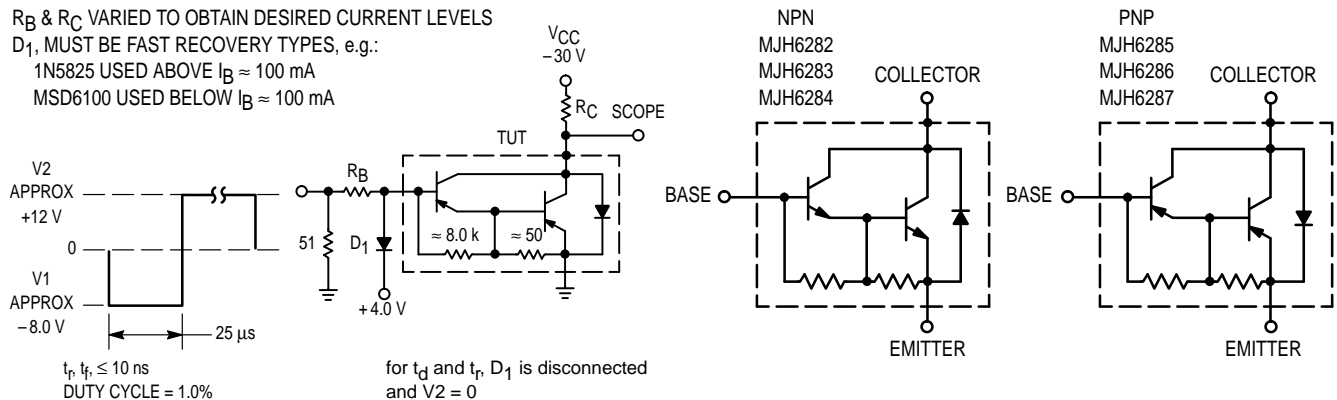

For NPN test circuit reverse diode and voltage polarities.

Figure 2. Switching Times Test Circuit

Figure 3. Darlington Schematic

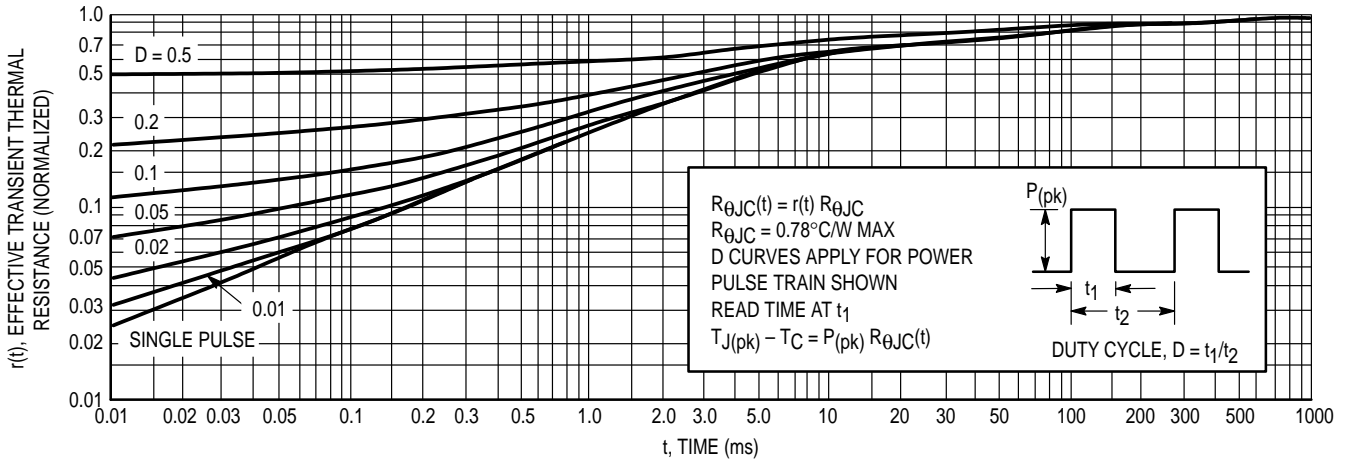

Figure 4. Thermal Response

FBSOA, FORWARD BIAS SAFE OPERATING AREA

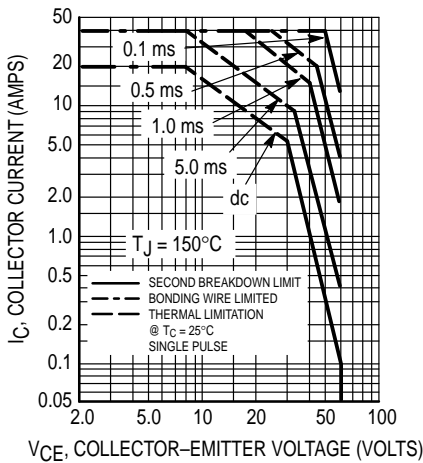

Figure 5. MJH6282, MJH6285

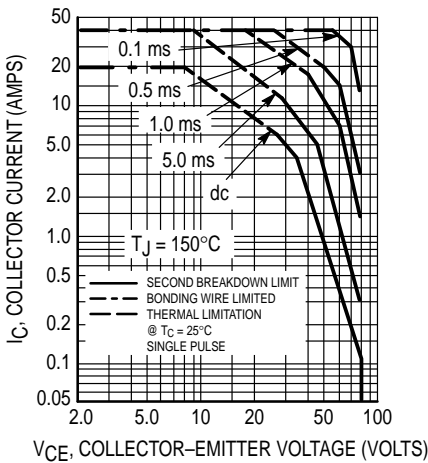

Figure 6. MJH6283, MJH6286

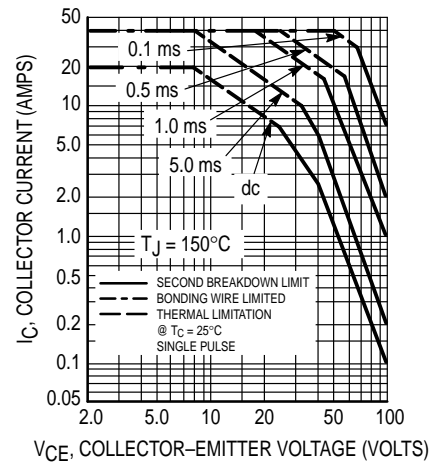

Figure 7. MJH6284, MJH6287

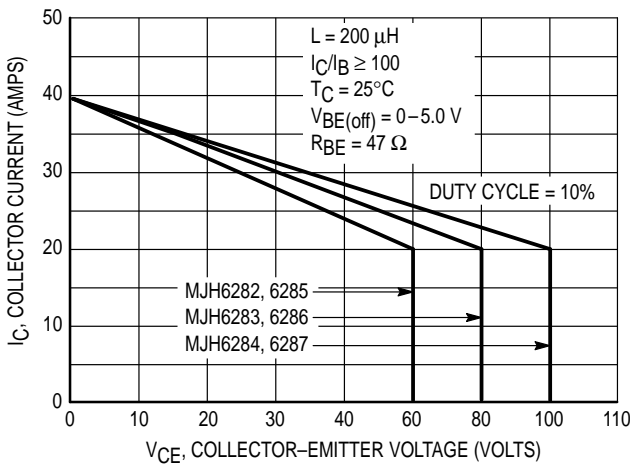

Figure 8. Maximum RBSOA, Reverse Bias Safe Operating Area

FORWARD BIAS

There are two limitations on the power handling ability of a transistor: average junction temperature and second breakdown. Safe operating area curves indicate $I_C - V_{CE}$ limits of the transistor that must be observed for reliable operation; i.e., the transistor must not be subjected to greater dissipation than the curves indicate.

The data of Figure 5, 6 and 7 is based on $T_J(pk) = 150^{\circ}\text{C}$; T_C is variable depending on conditions. Second breakdown pulse limits are valid for duty cycles to 10% provided $T_J(pk) \leq 150^{\circ}\text{C}$. $T_J(pk)$ may be calculated from the data in Figure 4. At high case temperatures, thermal limitations will reduce the power that can be handled to values less than the limitations imposed by second breakdown.

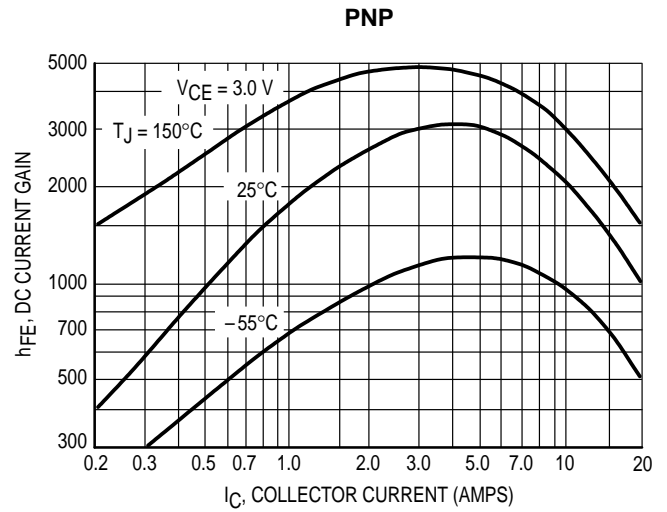
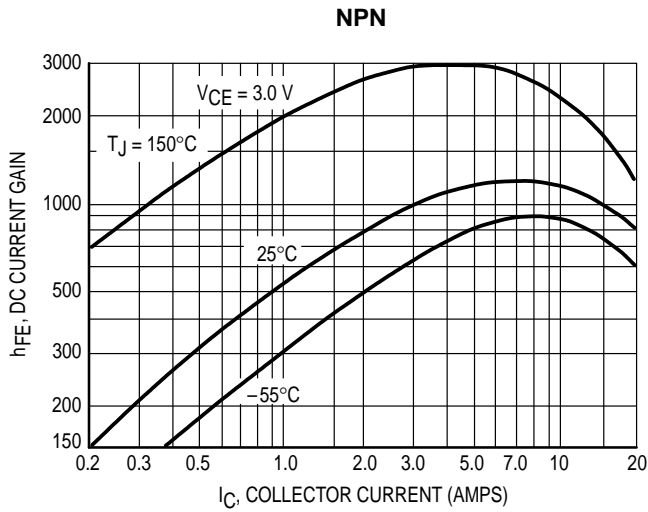

Figure 9. DC Current Gain

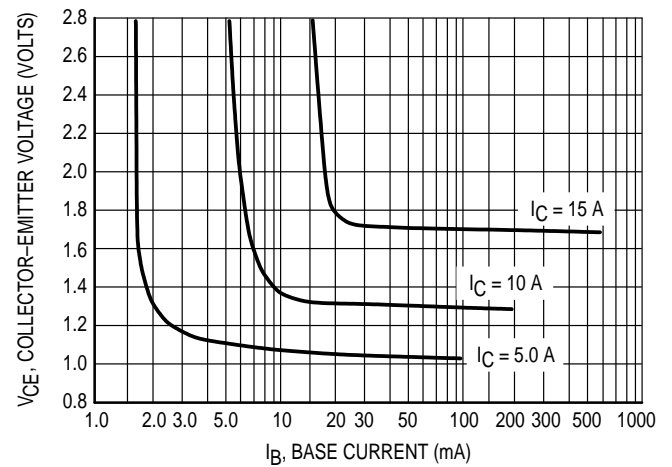
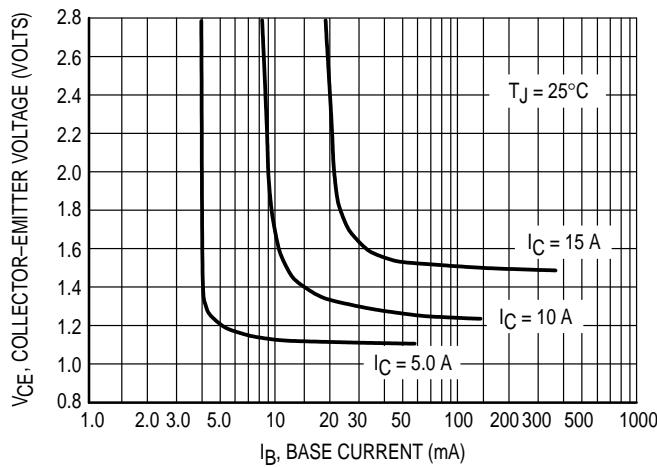

Figure 10. Collector Saturation Region

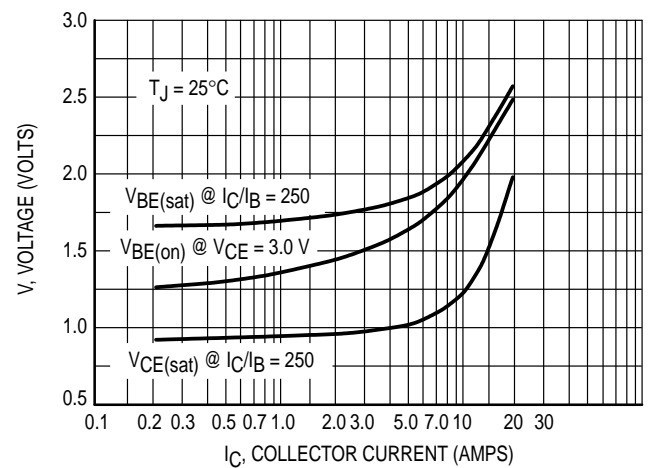
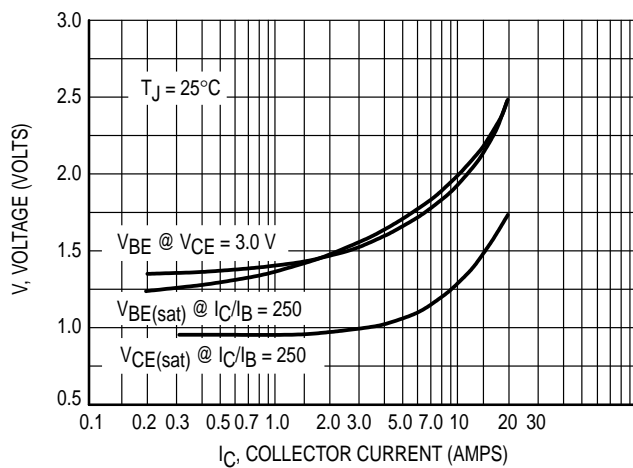
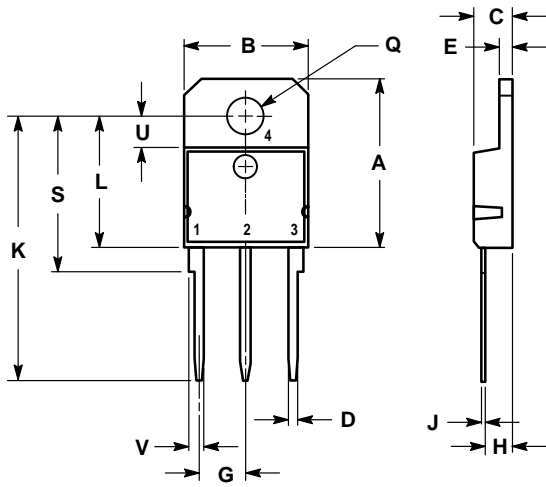

Figure 11. "On" Voltages

MJH6282 MJH6283 MJH6284 MJH6285 MJH6286 MJH6287

PACKAGE DIMENSIONS



- NOTES:
 1. DIMENSIONING AND TOLERANCING PER ANSI Y14.5M, 1982.
 2. CONTROLLING DIMENSION: MILLIMETER.

DIM	MILLIMETERS		INCHES	
	MIN	MAX	MIN	MAX
A	19.00	19.60	0.749	0.771
B	14.00	14.50	0.551	0.570
C	4.20	4.70	0.165	0.185
D	1.00	1.30	0.040	0.051
E	1.45	1.65	0.058	0.064
G	5.21	5.72	0.206	0.225
H	2.60	3.00	0.103	0.118
J	0.40	0.60	0.016	0.023
K	28.50	32.00	1.123	1.259
L	14.70	15.30	0.579	0.602
Q	4.00	4.25	0.158	0.167
S	17.50	18.10	0.689	0.712
U	3.40	3.80	0.134	0.149
V	1.50	2.00	0.060	0.078

- STYLE 1:
 PIN 1. BASE
 2. COLLECTOR
 3. EMITTER
 4. COLLECTOR

CASE 340D-01
 ISSUE A

Motorola reserves the right to make changes without further notice to any products herein. Motorola makes no warranty, representation or guarantee regarding the suitability of its products for any particular purpose, nor does Motorola assume any liability arising out of the application or use of any product or circuit, and specifically disclaims any and all liability, including without limitation consequential or incidental damages. "Typical" parameters can and do vary in different applications. All operating parameters, including "Typicals" must be validated for each customer application by customer's technical experts. Motorola does not convey any license under its patent rights nor the rights of others. Motorola products are not designed, intended, or authorized for use as components in systems intended for surgical implant into the body, or other applications intended to support or sustain life, or for any other application in which the failure of the Motorola product could create a situation where personal injury or death may occur. Should Buyer purchase or use Motorola products for any such unintended or unauthorized application, Buyer shall indemnify and hold Motorola and its officers, employees, subsidiaries, affiliates, and distributors harmless against all claims, costs, damages, and expenses, and reasonable attorney fees arising out of, directly or indirectly, any claim of personal injury or death associated with such unintended or unauthorized use, even if such claim alleges that Motorola was negligent regarding the design or manufacture of the part. Motorola and  are registered trademarks of Motorola, Inc. Motorola, Inc. is an Equal Opportunity/Affirmative Action Employer.

How to reach us:

USA / EUROPE: Motorola Literature Distribution;
P.O. Box 20912; Phoenix, Arizona 85036. 1-800-441-2447

JAPAN: Nippon Motorola Ltd.; Tatsumi-SPD-JLDC, Toshikatsu Otsuki,
6F Seibu-Butsuryu-Center, 3-14-2 Tatsumi Koto-Ku, Tokyo 135, Japan. 03-3521-8315

MFAX: RMFAX0@email.sps.mot.com – TOUCHTONE (602) 244-6609
INTERNET: <http://Design-NET.com>

HONG KONG: Motorola Semiconductors H.K. Ltd.; 8B Tai Ping Industrial Park,
51 Ting Kok Road, Tai Po, N.T., Hong Kong. 852-26629298

