

The RF Line

Microwave Pulse Power Transistors

Designed for Class B and C common base amplifier applications in short pulse TACAN, IFF, and DME transmitters.

- Guaranteed Performance @ 1090 MHz, 50 Vdc
Output Power = 150 Watts Peak
Minimum Gain = 7.8 dB
- 100% Tested for Load Mismatch at All Phase Angles with 10:1 VSWR
- Industry Standard Package
- Nitride Passivated
- Gold Metallized, Emitter Ballasted for Long Life and Resistance to Metal Migration
- Internal Input Matching for Broadband Operation
- Circuit board photomaster available upon request by contacting RF Tactical Marketing in Phoenix, AZ.

MRF1150MA
MRF1150MB

150 W PEAK, 960–1215 MHz
MICROWAVE POWER
TRANSISTORS
NPN SILICON

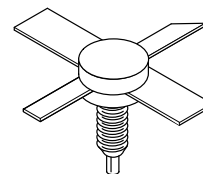

CASE 332-04, STYLE 1
(MRF1150MA)

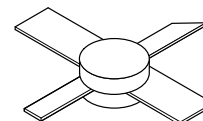

CASE 332A-03, STYLE 1
(MRF1150MB)

MAXIMUM RATINGS

Rating	Symbol	Value	Unit
Collector–Base Voltage	V_{CB0}	70	Vdc
Emitter–Base Voltage	V_{EBO}	4.0	Vdc
Collector Current — Peak (1)	I_C	12	Adc
Total Device Dissipation @ $T_C = 25^\circ\text{C}$ (1) (2) Derate above 25°C	P_D	583 3.33	Watts W/ $^\circ\text{C}$
Storage Temperature Range	T_{stg}	-65 to +150	$^\circ\text{C}$

THERMAL CHARACTERISTICS

Characteristic	Symbol	Max	Unit
Thermal Resistance, Junction to Case (3)	$R_{\theta JC}$	0.3	$^\circ\text{C/W}$

ELECTRICAL CHARACTERISTICS ($T_C = 25^\circ\text{C}$ unless otherwise noted)

Characteristic	Symbol	Min	Typ	Max	Unit
----------------	--------	-----	-----	-----	------

OFF CHARACTERISTICS

Collector–Emitter Breakdown Voltage ($I_C = 50$ mAdc, $V_{BE} = 0$)	$V_{(BR)CES}$	70	—	—	Vdc
Collector–Base Breakdown Voltage ($I_C = 50$ mAdc, $I_E = 0$)	$V_{(BR)CBO}$	70	—	—	Vdc
Emitter–Base Breakdown Voltage ($I_E = 5.0$ mAdc, $I_C = 0$)	$V_{(BR)EBO}$	4.0	—	—	Vdc
Collector Cutoff Current ($V_{CB} = 50$ Vdc, $I_E = 0$)	I_{CBO}	—	—	10	mAdc

ON CHARACTERISTICS

DC Current Gain (4) ($I_C = 5.0$ Adc, $V_{CE} = 5.0$ Vdc)	h_{FE}	10	30	—	—
---	----------	----	----	---	---

NOTES:

1. Pulse Width = 10 μs , Duty Cycle = 1%.
2. These devices are designed for RF operation. The total device dissipation rating applies only when the device is operated as RF amplifiers.
3. Thermal Resistance is determined under specified RF operating conditions by infrared measurement techniques.
4. 80 μs Pulse on Tektronix 576 or equivalent.

(continued)

ELECTRICAL CHARACTERISTICS — continued ($T_C = 25^\circ\text{C}$ unless otherwise noted)

Characteristic	Symbol	Min	Typ	Max	Unit
DYNAMIC CHARACTERISTICS					
Output Capacitance ($V_{CB} = 50\text{ Vdc}$, $I_E = 0$, $f = 1.0\text{ MHz}$)	C_{ob}	—	25	32	pF
FUNCTIONAL TESTS (Pulse Width = $10\ \mu\text{s}$, Duty Cycle = 1.0%)					
Common-Base Amplifier Power Gain ($V_{CC} = 50\text{ Vdc}$, $P_{Out} = 150\text{ W pk}$, $f = 1090\text{ MHz}$)	GPB	7.8	9.8	—	dB
Collector Efficiency ($V_{CC} = 50\text{ Vdc}$, $P_{Out} = 150\text{ W pk}$, $f = 1090\text{ MHz}$)	η	35	40	—	%
Load Mismatch ($V_{CC} = 50\text{ Vdc}$, $P_{Out} = 150\text{ W pk}$, $f = 1090\text{ MHz}$, $VSWR = 10:1$ All Phase Angles)	ψ	No Degradation in Power Output			

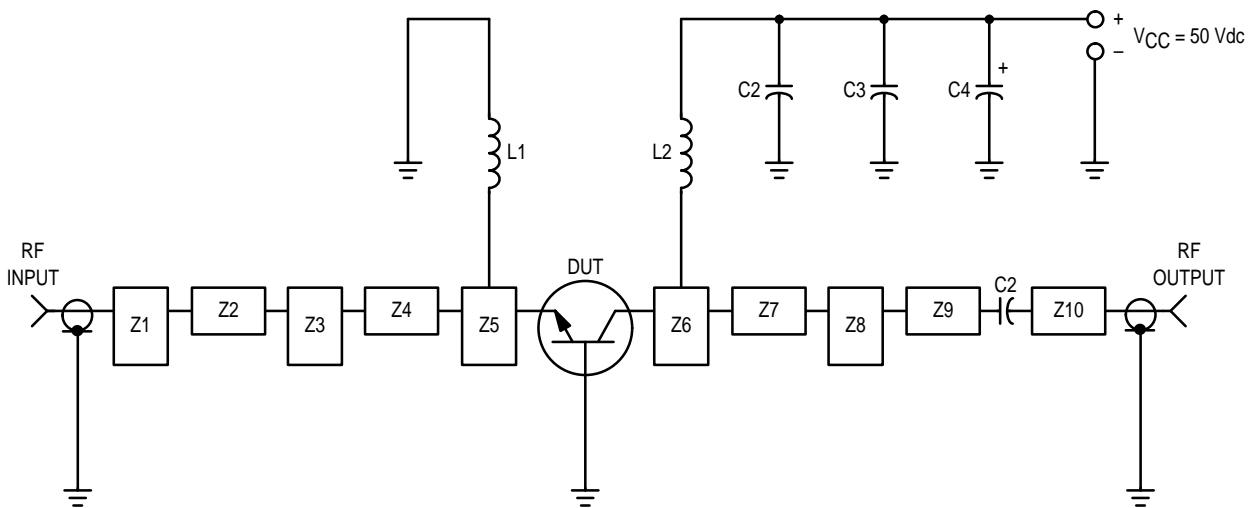

C1, C2 — 220 pF Chip Capacitor, 100-mil ATC
 C3 — 0.1 $\mu\text{F}/100\text{ V}$
 C4 — 47 $\mu\text{F}/75\text{ V}$ Electrolytic
 L1, L2 — 3 Turns #18 AWG, 1/8" ID
 Z1–Z10 — Distributed Microstrip Elements — See Photomaster
 Board Material — 0.031" Thick Teflon-Fiberglass, $\epsilon_r = 2.5$

Figure 1. 1090 MHz Test Circuit

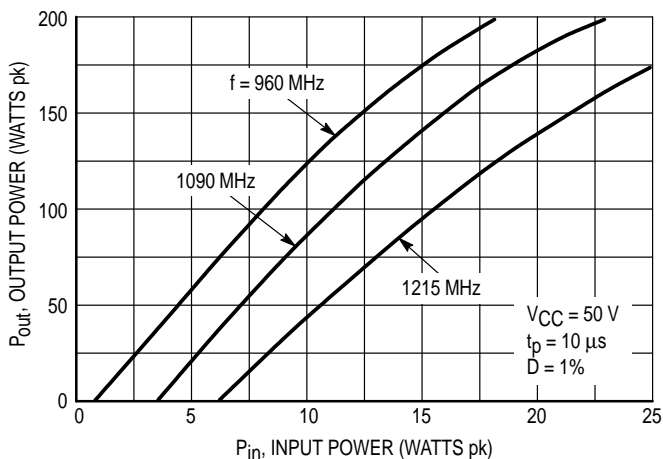

Figure 2. Output Power versus Input Power

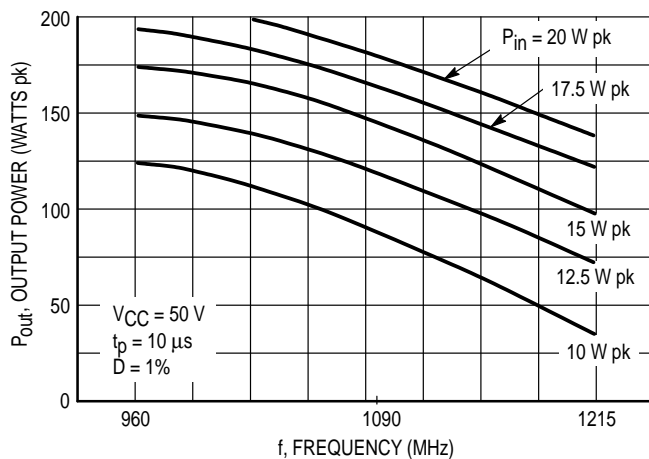

Figure 3. Output Power versus Frequency

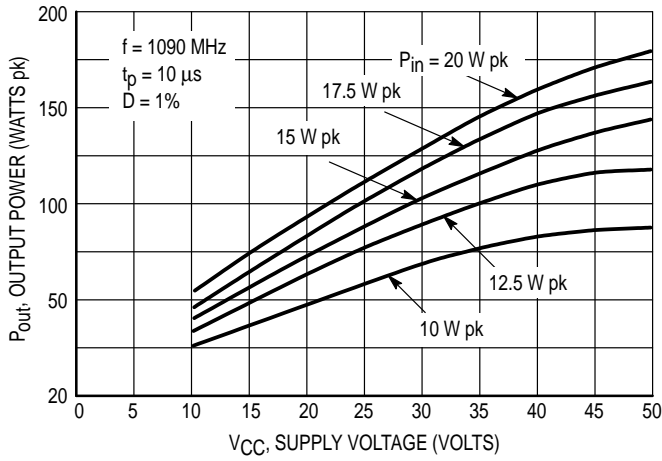

Figure 4. Output Power versus Supply Voltage

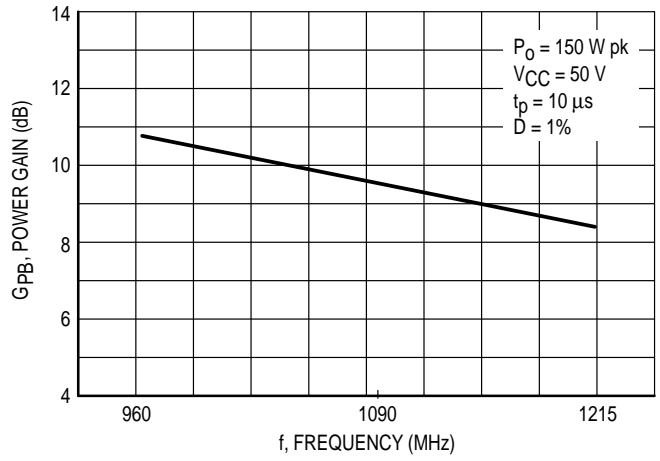
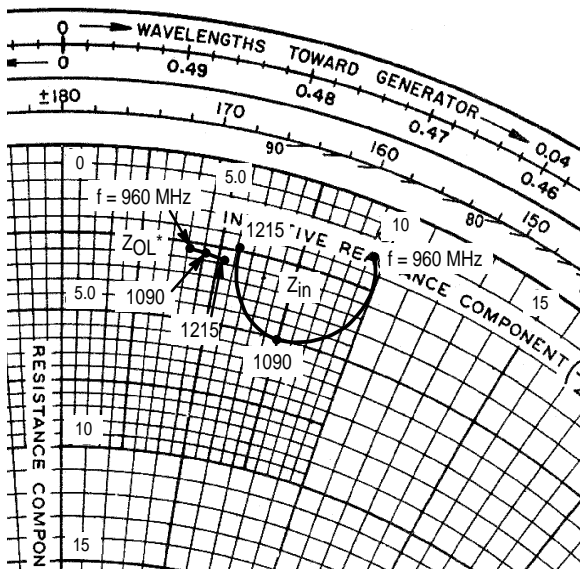

Figure 5. Power Gain versus Frequency



$P_{out} = 150$ W pk $V_{CC} = 50$ V
 $t_p = 10 \mu s$ $D = 1\%$

f MHz	Z_{in} Ohms	Z_{OL}^* Ohms
960	$1.5 + j9.6$	$2.6 + j4.1$
1090	$5.0 + j7.5$	$2.7 + j4.6$
1215	$2.4 + j5.6$	$2.8 + j5.3$

Z_{OL}^* = Conjugate of the optimum load impedance into which the device output operates at a given output power, voltage, and frequency.

Figure 6. Series Equivalent Input/Output Impedance

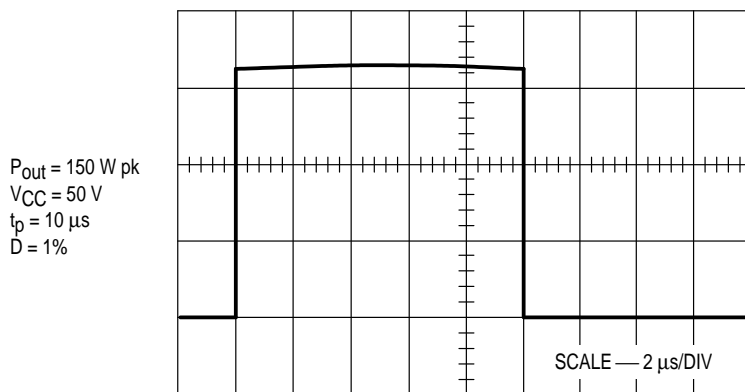
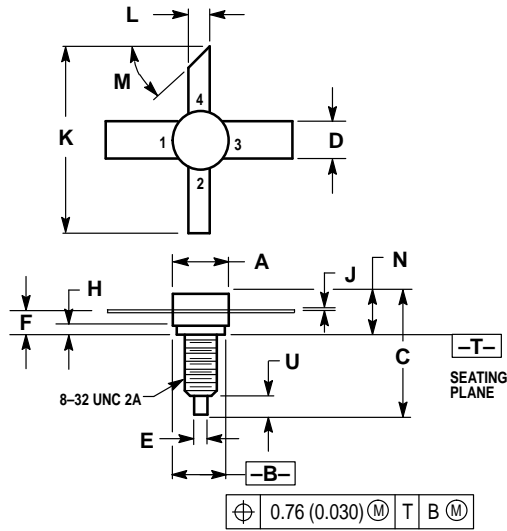

Figure 7. Typical Pulse Performance

PACKAGE DIMENSIONS



- NOTES:
 1. DIMENSION K APPLIES TWO PLACES.
 2. DIMENSIONING AND TOLERANCING PER ANSI Y14.5M, 1973.

DIM	MILLIMETERS		INCHES	
	MIN	MAX	MIN	MAX
A	6.86	7.62	0.270	0.300
B	6.10	6.60	0.240	0.260
C	16.26	16.76	0.640	0.660
D	4.95	5.21	0.195	0.205
E	1.40	1.65	0.055	0.065
F	2.67	4.32	0.105	0.170
H	1.40	1.65	0.055	0.065
J	0.08	0.18	0.003	0.007
K	15.24	—	0.600	—
L	2.41	2.67	0.095	0.105
M	45°NOM	—	45°NOM	—
N	4.97	6.22	0.180	0.245
U	2.92	3.68	0.115	0.145

- STYLE 1:
 PIN 1. BASE
 2. EMITTER
 3. BASE
 4. COLLECTOR

**CASE 332-04
 ISSUE D
 (MRF1150MA)**

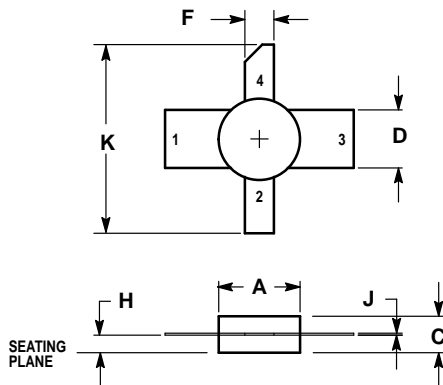

- NOTES:
 1. DIMENSIONING AND TOLERANCING PER ANSI Y14.5M, 1982.
 2. CONTROLLING DIMENSION: INCH.

DIM	INCHES		MILLIMETERS	
	MIN	MAX	MIN	MAX
A	0.270	0.290	6.86	7.36
C	0.115	0.135	2.93	3.42
D	0.195	0.205	4.96	5.20
F	0.095	0.105	2.42	2.66
H	0.050	0.070	1.27	1.77
J	0.003	0.007	0.08	0.17
K	0.600	—	15.24	—

- STYLE 1:
 PIN 1. BASE
 2. EMITTER
 3. BASE
 4. COLLECTOR

**CASE 332A-03
 ISSUE D
 (MRF1150MB)**

Motorola reserves the right to make changes without further notice to any products herein. Motorola makes no warranty, representation or guarantee regarding the suitability of its products for any particular purpose, nor does Motorola assume any liability arising out of the application or use of any product or circuit, and specifically disclaims any and all liability, including without limitation consequential or incidental damages. "Typical" parameters which may be provided in Motorola data sheets and/or specifications can and do vary in different applications and actual performance may vary over time. All operating parameters, including "Typicals" must be validated for each customer application by customer's technical experts. Motorola does not convey any license under its patent rights nor the rights of others. Motorola products are not designed, intended, or authorized for use as components in systems intended for surgical implant into the body, or other applications intended to support or sustain life, or for any other application in which the failure of the Motorola product could create a situation where personal injury or death may occur. Should Buyer purchase or use Motorola products for any such unintended or unauthorized application, Buyer shall indemnify and hold Motorola and its officers, employees, subsidiaries, affiliates, and distributors harmless against all claims, costs, damages, and expenses, and reasonable attorney fees arising out of, directly or indirectly, any claim of personal injury or death associated with such unintended or unauthorized use, even if such claim alleges that Motorola was negligent regarding the design or manufacture of the part. Motorola and  are registered trademarks of Motorola, Inc. Motorola, Inc. is an Equal Opportunity/Affirmative Action Employer.

Mfax is a trademark of Motorola, Inc.

How to reach us:

USA/EUROPE/Locations Not Listed: Motorola Literature Distribution;
P.O. Box 5405, Denver, Colorado 80217. 303-675-2140 or 1-800-441-2447

JAPAN: Nippon Motorola Ltd.: SPD, Strategic Planning Office, 4-32-1,
Nishi-Gotanda, Shinagawa-ku, Tokyo 141, Japan. 81-3-5487-8488

Mfax™: RMFAX0@email.sps.mot.com – TOUCHTONE 602-244-6609
– US & Canada ONLY 1-800-774-1848

ASIA/PACIFIC: Motorola Semiconductors H.K. Ltd.; 8B Tai Ping Industrial Park,
51 Ting Kok Road, Tai Po, N.T., Hong Kong. 852-26629298

INTERNET: <http://motorola.com/sps>



MRF1150MA/D